



**MOTOROLA**  
*intelligence everywhere™*



V3  
GSM

***MOTOMANUAL***



# Welcome

---

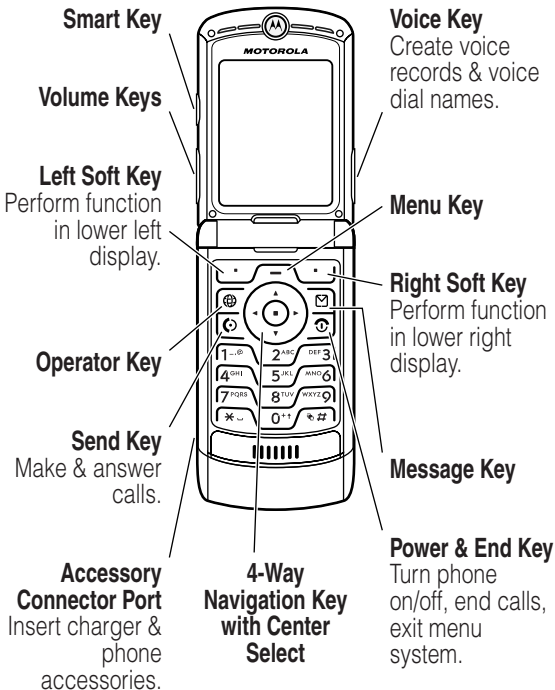

Welcome to the world of Motorola digital wireless communications! We are pleased that you have chosen the Motorola V3 GSM wireless phone.

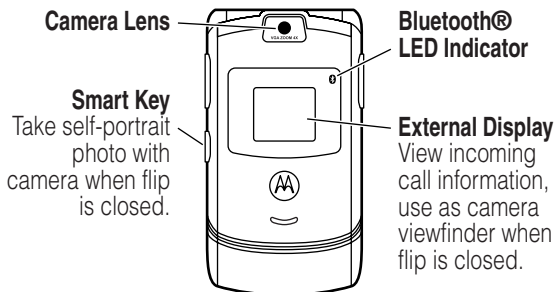

# Check It Out!



Feature	Description
<b>Take Photo</b>	Press <b>CAMERA</b> (📷) to activate the camera, point lens at subject, press <b>CAPTURE</b> (📷) to take a photo.
<b>Take Self-Portrait</b> (flip closed)	Activate the camera, close the flip, use viewfinder to aim lens, press smart key to take a photo.
<b>Send Photo</b>	Send a photo to a phone number or email address: Take photo, then press <b>STORE</b> (📷) > <b>Send In Message.</b>

Feature	Description
<b>Set Photo as Picture ID</b>	Assign a photo to a phonebook entry to allow picture caller ID: Take photo, then press <b>STORE</b> (⏏) > <b>Apply as Phonebook Entry.</b>
<b>Send Multimedia Message</b>	Send a multimedia message with pictures, animations, sounds, and videos:  > <b>Create Message</b> > <b>New Multimedia Msg</b>
<b>Wireless Connection</b>	Set up a Bluetooth® wireless connection to a headset accessory, car kit, or external device:  > <b>Settings</b> > <b>Connection</b> > <b>Bluetooth Link</b> > <b>Setup</b> > <b>Power</b> > <b>On</b> , press <b>BACK</b> (⏏), press > <b>Handsfree</b> > <b>[Look For Devices]</b>



Motorola, Inc.  
Consumer Advocacy Office  
1307 East Algonquin Road  
Schaumburg, IL 60196

[www.motorola.com](http://www.motorola.com)

1-800-331-6456 (United States)

1-888-390-6456 (TTY/TDD United States for hearing impaired)

1-800-461-4575 (Canada)

MOTOROLA and the Stylized M Logo are registered in the US Patent & Trademark Office. The Bluetooth trademarks are owned by their proprietor and used by Motorola, Inc. under license. Java and all other Java-based marks are trademarks or registered trademarks of Sun Microsystems, Inc. in the U.S. and other countries. All other product or service names are the property of their respective owners.

© Motorola, Inc. 2004.

The information contained in Motorola's user's guides is believed to be correct at the time of printing. Motorola reserves the right to change or modify any information or specifications without notice. The contents of Motorola's user's guides are provided "as is." Except as required by applicable law, no warranties of any kind, either express or implied, including, but not limited to, the implied warranties of merchantability and fitness for a particular purpose, are made in relation to the accuracy, reliability, or contents of this guide.

**Caution:** Changes or modifications made in the radio phone, not expressly approved by Motorola, will void the user's authority to operate the equipment.

Manual number: 6809491A47-O

# Contents

---

<b>Getting Started</b> . . . . .	8
About This Guide . . . . .	8
Installing the SIM Card . . . . .	9
Battery Tips . . . . .	10
Installing the Battery . . . . .	11
Charging the Battery. . . . .	11
Turning Your Phone On. . . . .	13
Turning Your Phone Off. . . . .	13
Adjusting Volume . . . . .	14
Making a Call . . . . .	14
Answering a Call. . . . .	15
Viewing Your Phone Number . . . . .	15
<b>Highlight Features</b> . . . . .	16
Taking and Sending a Photo. . . . .	16
Sending a Multimedia Message . . . . .	19
Using a Bluetooth® Wireless Connection. . . . .	23
<b>Learning to Use Your Phone</b> . . . . .	26
Using the Display . . . . .	26
Using the 4-Way Navigation Key. . . . .	31
Using the Operator Key . . . . .	31
Using the Message Key . . . . .	31
Using Menus. . . . .	32
Entering Text. . . . .	34
Using the Smart Key. . . . .	46
Using the External Display . . . . .	46
Using the Handsfree Speaker. . . . .	48
Changing a Code, PIN, or Password . . . . .	48
Locking and Unlocking Your Phone . . . . .	49

If You Forget a Code, PIN, or Password . . . . .	50
Using the Phonebook . . . . .	51
<b>Setting Up Your Phone</b> . . . . .	54
Setting a Ring Style . . . . .	54
Changing the Call Alert . . . . .	55
Setting the Time and Date . . . . .	55
Setting a Wallpaper Image . . . . .	56
Setting a Screen Saver Image . . . . .	57
Changing Phone Skin . . . . .	58
Setting a Phone Theme . . . . .	58
Setting Answer Options . . . . .	59
Setting Display Brightness . . . . .	60
Adjusting the Backlight . . . . .	60
Setting Display Timeout . . . . .	61
Storing Your Name and Phone Number . . . . .	61
<b>Calling Features</b> . . . . .	62
Turning Off a Call Alert . . . . .	62
Viewing Recent Calls . . . . .	62
Redialing a Number . . . . .	64
Using Automatic Redial . . . . .	64
Returning an Unanswered Call . . . . .	65
Using the Notepad . . . . .	65
Putting a Call On Hold or Mute . . . . .	66
Using Call Waiting . . . . .	66
Using Caller ID (Incoming Calls) . . . . .	67
Calling an Emergency Number . . . . .	68
Dialing International Numbers . . . . .	68
Calling With 1-Touch Dial . . . . .	68
Using Voicemail . . . . .	69
Changing the Active Line . . . . .	71



<b>Phone Features</b> .....	72
Main Menu .....	72
Settings Menu .....	73
Feature Quick Reference .....	74
Calling Features .....	74
Messages .....	75
Phonebook .....	76
Personalizing Features .....	80
Instant Messaging .....	81
Chat .....	82
Email .....	83
Menu Features .....	83
Special Dialing Features .....	84
Call Monitoring .....	85
Handsfree Features .....	86
Data and Fax Calls .....	87
Bluetooth® Wireless Connections .....	88
Network Features .....	89
Personal Organizer Features .....	90
Security .....	91
News and Entertainment .....	92
<b>Troubleshooting</b> .....	95
<b>Specific Absorption Rate Data</b> .....	96
<b>European Union Directives Conformance Statement</b> ..	98
<b>Index</b> .....	99

# Getting Started



**CAUTION:** Before using the phone for the first time, read the *Important Safety and Legal Information* included in the gray-edged pages at the back of this guide.



## About This Guide



This guide describes the basic features of your phone.

### Selecting a Menu Feature

Use the menu system to access your phone's features. This guide shows you how to select a menu feature from the home screen as follows:

**Find the Feature**      > **Recent Calls** > **Dialed Calls**

This example shows that, from the home screen, you must press the menu key  to open the menu, scroll to and select  **Recent Calls**, then scroll to and select **Dialed Calls**.

Press the 4-way navigation key  to scroll and highlight a menu feature. Press **SELECT** () to select the highlighted menu feature.

## Optional Features



This label identifies an optional network, SIM card, or subscription-dependent feature that may not be offered by all service providers in all geographical areas. Contact your service provider for more information.

## Optional Accessories



This label identifies a feature that requires an optional Motorola Original™ accessory.

## Installing the SIM Card

Your *Subscriber Identity Module* (SIM) card contains your phone number, service details, and phonebook/message memory.

**Caution:** Do not bend or scratch your SIM card. Avoid exposing your SIM card to static electricity, water, or dirt.

Slide the SIM card under the retention strap to insert it into the card slot as shown below:

1.

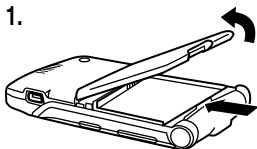

2.

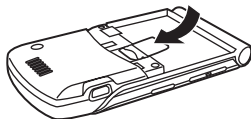

# Battery Tips



Battery life depends on the network, signal strength, temperature, features, and accessories you use.

- Always use Motorola Original batteries and chargers. The warranty does not cover damage caused by using non-Motorola batteries and/or chargers.
- New batteries or batteries stored for a long time may take more time to charge.
- When charging your battery, keep it near room temperature.
- When storing your battery, keep it uncharged in a cool, dark, dry place, such as a refrigerator.
- Never expose batteries to temperatures below  $-10^{\circ}\text{C}$  ( $14^{\circ}\text{F}$ ) or above  $45^{\circ}\text{C}$  ( $113^{\circ}\text{F}$ ). Always take your phone with you when you leave your vehicle.
- It is normal for batteries to gradually wear down and require longer charging times. If you notice a change in your battery life, it is probably time to purchase a new battery.



Contact your local recycling center for proper battery disposal.

**Warning:** Never dispose of batteries in a fire because they may explode.

Before using your phone, read the battery safety information in the “Safety and General Information” section included in the gray-edged pages at the back of this guide.

## Installing the Battery

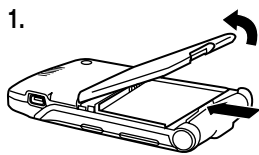
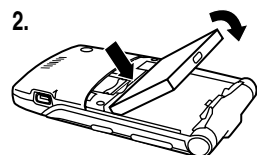
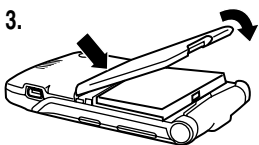
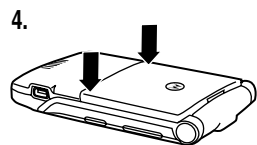
1. 
2. 
3. 
4. 



## Charging the Battery

New batteries are shipped partially charged. Before you can use your phone, you need to install and charge the battery as described below. Some batteries perform best after several full charge/discharge cycles.

**Tip:** The angle connector provided with your phone makes it easier for you to use the phone with an attached battery charger or phone accessory.



### Action

- 1 Insert the travel charger plug into the detachable angle connector as shown.
- 2 Insert the angle connector plug into the USB connector port on your phone.

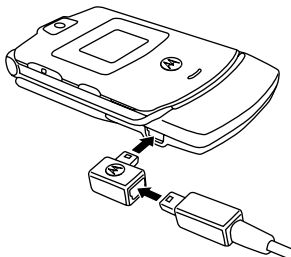

- 3 Plug the other end of the travel charger into the appropriate electrical outlet.

**Note:** It may take up to 10 seconds for your phone to provide a visible or audible indication that the battery is charging.

- 4 When your phone indicates **Charge Complete**, remove the travel charger and angle connector.

**Note:** You can safely leave the travel charger connected to the phone after charging is complete. This will **not** damage the battery.

# Turning Your Phone On

## Action

- 1 Press and hold the power key  for 2 seconds to turn the phone on.

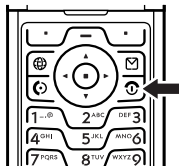

**Note:** It may take up to 4 seconds for the display to illuminate after you turn the phone on.



- 2 If necessary, enter your SIM card PIN code and press **OK** () to unlock the SIM card.

**Caution:** If you enter an incorrect PIN code 3 times in a row, your SIM card is disabled and your phone displays **SIM Blocked**.

- 3 If necessary, enter your 4-digit unlock code and press **OK** () to unlock the phone.

At startup, you may be prompted to personalize your phone. Select **YES** () to set personal phone options, or **NO** () to go to the home screen. For more information about personalizing your phone, see page 80.

# Turning Your Phone Off

## Action

Press and hold the power key  for 2 seconds to turn the phone off.



## Adjusting Volume

Press the up or down volume keys to:

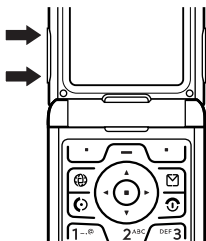

- silence an incoming call alert
- increase or decrease earpiece volume during a call
- increase or decrease ringer volume when the home screen is visible (flip must be open)

**Tip:** At the lowest volume setting, press the down volume key once to switch to vibrate alert. Press it again to switch to silent alert. Press the up volume key to switch back to vibrate alert, then ring alert.



## Making a Call

You must be in the home screen to dial a phone number (see page 26).

Press	To
1 keypad keys	dial the phone number
2 	make the call
3 	end the call and “hang up” the phone when you are finished

**Tip:** You can also close the phone flip to end the call.





# Answering a Call



When you receive a call, your phone rings and/or vibrates and displays an incoming call message.

When the phone flip is active, open the phone to answer the call. (To activate, press  > **Settings** > **In Call Setup** > **Answer Options** > **Open To Answer.**)

If the phone flip is **not** active:

Press	To
1  or <b>ANSWER</b> (  )	answer the call
2 	end the call and “hang up” the phone when you are finished

# Viewing Your Phone Number

To view your phone number from the home screen, press  .

While you are on a call, press  > **My Tel. Numbers.**

**Note:** Your phone number must be stored on your SIM card to use this feature. To store your phone number on the SIM card, see page 61. If you do not know your phone number, contact your service provider.



# Highlight Features



You can do much more with your phone than make and receive calls!

## Taking and Sending a Photo

**Shortcut:** From the home screen, press **CAMERA** (⌘) to activate the camera.

To activate your phone's camera from the menu system:

**Find the Feature**     ⌘ > Multimedia > Camera

The active viewfinder image appears on your display.

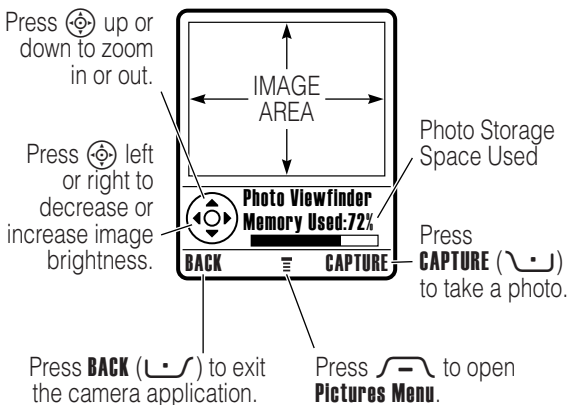

Point the camera lens at the photo subject, then:

Press	To
1 <b>CAPTURE</b> (⏺)	take a photo
2 <b>STORE</b> (⏺)	view storage options If you choose to store the photo, continue to step 3.
or	
<b>DISCARD</b> (⏺)	delete the photo and return to active viewfinder
3 	scroll to <b>Send in Message, Store Only, Apply as Wallpaper, Apply as Screen Saver, or Apply as Phonebook Entry</b>
4 <b>SELECT</b> (⏺)	perform the storage option



## *Taking a Self-Portrait*

Action
1 From the home screen, press <b>CAMERA</b> (⏺) to activate the camera, then close the flip. or Close the flip, then press and hold the smart key to activate the camera and external display viewfinder.
2 Use the external viewfinder to aim the camera lens.

## Action

- 3 Press the smart key to take a photo.
- 4 Wait 5 seconds for your phone to save the photo and reset the external viewfinder.

or

Open the flip to store or discard the photo.



## Adjusting Camera Settings

Press  to open the **Pictures Menu** when the camera is active. The **Pictures Menu** can include the following options:

Option	Description
<b>Go To Pictures</b>	View pictures and photos stored on your phone.
<b>Auto-Timed Capture</b>	Set a timer for the camera to take a photo.
<b>Pictures Setup</b>	Open the setup menu to adjust the following settings:
	<ul style="list-style-type: none"><li>• <b>Auto Repeat:</b> Return to the beginning when the last picture displays in a picture album slideshow.</li><li>• <b>Shuffle:</b> Set pictures to display randomly when viewing a picture album slideshow.</li><li>• <b>Allow Alert:</b> Enable or disable all phone sound/vibration alerts when taking a picture.</li></ul>
	<ul style="list-style-type: none"><li>• <b>Lighting Conditions:</b> Set to <b>Automatic</b>, <b>Sunny</b>, <b>Cloudy</b>, <b>Indoor (Home)</b>, <b>Indoor (Office)</b>, or <b>Night</b>.</li></ul>
	<ul style="list-style-type: none"><li>• <b>Exposure:</b> Set to <b>+2</b>, <b>+1</b>, <b>0</b>, <b>-1</b>, or <b>-2</b>.</li></ul>



Option	Description
	<ul style="list-style-type: none"> <li>• <b>Resolution:</b> Set the camera to capture photos at the following resolutions: <b>MMS</b> (160x120 pixels), <b>Medium</b> (320x240 pixels, or <b>High</b> (640x480 pixels)</li> </ul>
	<ul style="list-style-type: none"> <li>• <b>Shutter Tone:</b> Activate a tone that sounds when you take a photo. Can be set to <b>None</b>, <b>Chimp</b>, <b>Quack</b>, <b>Flix</b>, <b>Boing</b>, or <b>Click</b>.</li> </ul>
<b>View Free Space</b>	See how much memory remains for storing pictures.



## ***Sending a Multimedia Message***



A *Multimedia Messaging Service* (MMS) multimedia message contains one or more pages with text and embedded media objects (including photos, pictures, animations, sounds, voice records, and video clips). You can send a multimedia message to other MMS-capable phones, and to email addresses.











**Tip:** The layout of all pages in a multimedia message is defined by the layout of the first page. To display a media object at the top of the page, insert it in the first half of the message text. To display a media object at the bottom of the page, insert it in the second half of the message text.

### **Find the Feature**



- > **Create Message**
- > **New Multimedia Msg**

Press	To
1 keypad keys	enter text on the page
2	open the <b>MMS Menu</b>



Press	To
3 	scroll to <b>Insert</b>
4 <b>SELECT</b> (  )	display a list of items you can insert
5 	scroll to <b>Picture, Voice Record, Sound, Video, New Page, Quick Note, or Contact Info</b>
6 <b>SELECT</b> (  )	select the file type
7 	highlight the file you want
8 <b>SELECT</b> (  )	insert the file
	To add another page to the message, continue to step 9.
9 	open the <b>MMS Menu</b> to insert a new page
10 	scroll to <b>Insert</b>
11 <b>SELECT</b> (  )	display a list of items you can insert
12 	scroll to <b>New Page</b>
13 <b>SELECT</b> (  )	insert a new page after the current page
	Repeat steps 1 to 8 to enter contents for the new page.

When you finish composing the multimedia message:

Press	To
1 <b>OK</b> (↵)	store the message
2 	scroll to a <b>Send To</b> option:  Highlight an existing phonebook entry.  Or highlight <b>[One Time Entry]</b> to enter one or more phone numbers or email addresses.  Or highlight <b>[New Phonebook Entry]</b> to enter a number/address and add it to the phonebook.
3 <b>ADD</b> (↵)	add the phonebook entry to the list of recipients  Repeat steps 2 and 3 to add additional phonebook entries to the list.
or	
<b>SELECT</b> (↵)	select <b>[One Time Entry]</b> or <b>[New Phonebook Entry]</b>
4 <b>DONE</b> (↵)	store the numbers/addresses
5 	scroll to <b>Subject</b>
6 <b>CHANGE</b> (↵)	select <b>Subject</b>
7 keypad keys	enter the subject





Press	To
8 <b>OK</b> (↵)	store the subject
9 <b>CHANGE</b> (↵)	select <b>Attachments</b> to attach a file to the message, if desired
10	scroll to <b>Picture, Sounds, or Video</b>
11 <b>SELECT</b> (↵)	select the file type
12	highlight the file you want
13 <b>SELECT</b> (↵)	attach the file
14 <b>BACK</b> (↵)	return to the message editor
15	scroll to <b>Receipt</b> to request a receipt, if desired
16 <b>CHANGE</b> (↵)	select <b>Receipt</b>
17 <b>ADD</b> (↵) or <b>REMOVE</b> (↵)	activate/deactivate the delivery report
18 <b>DONE</b> (↵)	return to the message editor
19 <b>SEND</b> (↵)	send the message
or	
	view message details, save the message in the drafts folder, or cancel the message



# Using a Bluetooth® Wireless Connection

Your phone supports Bluetooth wireless connections. You can set up a wireless link with a Bluetooth headset or handsfree car kit, or connect to a computer or hand-held device to exchange and synchronize data.



**Note:** Your phone's Bluetooth features and Bluetooth Class 1 power levels are not allowed for outdoor operation in France. To avoid unlawful interference with radio signals, do not use the Bluetooth features in France unless you are indoors.

## Turning Bluetooth Power On or Off

The preferred method for connecting your phone to a Bluetooth headset or handsfree car kit is to turn on Bluetooth power on your phone, then connect your phone to the headset or car kit.

To turn Bluetooth power on:

### Find the Feature

 > Settings > Connection  
> Bluetooth Link > Setup  
> Power > On

This procedure turns Bluetooth power on and leaves it on until you turn it off. When your phone's Bluetooth power is on, your handsfree accessory can automatically reconnect to the phone when you turn on the accessory or move it within range of the phone.

**Note:** To extend battery life, use the above procedure and set Bluetooth power to **Off** when not in use.

## Searching for Other Devices

To connect your phone to a Bluetooth headset or handsfree device:



### Find the Feature



 > **Settings** > **Connection**  
> **Bluetooth Link**  
> **Handsfree**  
> **[Look For Devices]**

If Bluetooth power is turned off, your phone prompts you to **Temporarily Power On?** the Bluetooth power setting. Press **YES** () to proceed. Alternatively, set **Power to On** in the **Setup** menu to turn Bluetooth power on and leave it on.

Your phone scans for and displays a list of device(s) located within range of the phone.

**Note:** If your phone is already connected to a device, you must disconnect from it to search for other devices.

To connect to a device, highlight the device name and press **SELECT** ()

The device may request permission to bond with your phone. Select **YES** () and enter the correct PIN code to create a secure connection with the device. When the connection is made, the Bluetooth indicator  displays in the home screen, and the external Bluetooth LED indicator flashes.

## ***Sending Objects to Another Device***

You can use a Bluetooth wireless connection to send a picture, sound, video, phonebook entry, datebook event, or bookmark from your phone to another phone, computer, or hand-held device.



### ***Sending a Picture, Sound, or Video***

Highlight the object on your phone that you want to send to the other device, then press  $\sqrt{\quad}$  > **Copy**.

Select a recognized device name listed in the **Object Exchange** menu, or **[Look For Devices]** to search for the device to which you want to send the object.

### ***Sending a Phonebook Entry, Datebook Event, or Bookmark***

Highlight the item on your phone that you want to send to the other device, then press  $\sqrt{\quad}$  > **Send**.

Select a recognized device name listed in the **Object Exchange** menu, or **[Look For Devices]** to search for the device to which you want to send the item.

# Learning to Use Your Phone



---



See page 1 for a basic phone diagram.

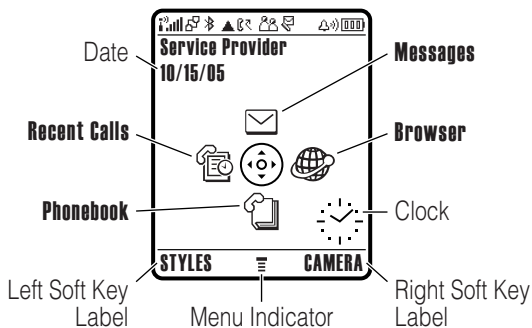

## Using the Display

The *home screen* is displayed when you are **not** on a call or using the menu. You must be in the home screen to dial a phone number.



Press the 4-way navigation key  up, down, left, or right to select a menu feature icon. If you select a menu icon by mistake, press  to return to the home screen.

The menu indicator  shows that you can press the menu key  to enter the main menu.

Labels at the bottom corners of the display show the current soft key functions. Press the left soft key  or right soft key  to perform the indicated function.

### Notes:

- Your home screen may appear different than shown. For example, the menu feature icons normally are hidden to allow a better view of the wallpaper image. You can still select the menu icons when they are hidden from view. To show or hide menu icons, see page 81.
- Your phone can display an analog or digital clock in the home screen (see page 80).
- Your phone's display normally is visible only when the display backlight is on, or when the display is viewed in direct sunlight. To extend battery life, the backlight turns off automatically when no activity is detected for a specified time. The backlight turns back on when you open the flip or press any key. To set the time that the backlight stays on, see page 60.
- To further extend battery life, you can set the display to turn off (in addition to the backlight) when no activity is detected for a specified time. The display turns back on when you open the flip or press any key. To set the time that the display stays on, see page 61.



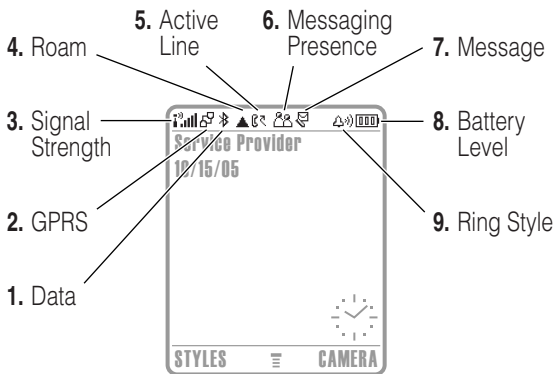

The following status indicators can display:





**1. Data Indicator** – Shows connection and data transmission status. The Bluetooth® wireless connection indicator  shows when a Bluetooth connection is active. Other indicators can include:

 = secure packet data transfer

 = unsecure packet data transfer

 = secure application connection

 = unsecure application connection

 = secure *Circuit Switch Data* (CSD) call

 = unsecure CSD call





**2. GPRS Indicator** – Shows that your phone is using a high-speed *General Packet Radio Service* (GPRS) network connection. GPRS allows faster data transfer speeds. Other

indicators can include:

 = GPRS PDP  
context active



 = GPRS packet  
data available

**3. Signal Strength Indicator** – Vertical bars show the strength of the network connection. You cannot make or receive calls when  or  displays.





**4. Roam Indicator** – The roam indicator  shows when your phone is seeking or using another network outside your home network.



**5. Active Line Indicator** – Shows  to indicate an active call, or  to indicate that call forwarding is on. Indicators for dual-line-enabled SIM cards can include:

 = line 1 active

 = line 2 active

 = line 1 active,  
call forward on

 = line 2 active, call  
forward on







**6. Messaging Presence Indicator** – Shows when instant messaging is active. Indicators can include:

 = IM active

 = available for IM

 = busy

 = invisible to IM

 = available for phone calls

 = offline

When a Java™ application is active, the Java midlet indicator  displays in this location.





**7. Message Indicator** – Displays when you receive a new message. Indicators can include:

 = text message

 = voicemail message

 = voicemail and text message

 = IM message

 = active chat session

**8. Battery Level Indicator** – Vertical bars show the battery charge level. Recharge the battery when **Low Battery** displays and the battery alert sounds.

**9. Ring Style Indicator** – Shows the ring style setting.

 = loud ring

 = soft ring

 = vibrate



 = vibrate then ring

 = vibrate & ring

 = silent



# Using the 4-Way Navigation Key

Press the 4-way navigation key  up, down, left, or right to scroll through the menu system, highlight menu items, change feature settings, and play games. Press the *center select* key  in the center of the 4-way navigation key to select a highlighted menu item. The center select key usually performs the same function as the right soft key .

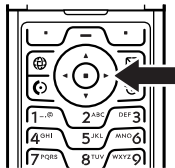

# Using the Operator Key

From the home screen, press the operator key  to go to your service provider's portal site to access customized content and services.

If a portal site is not available, press the operator key to start the micro-browser.

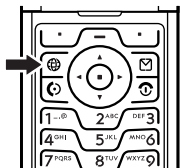

# Using the Message Key

From the home screen, press the message key  to send a message or read messages you have received.

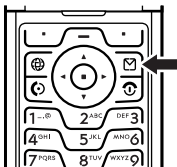





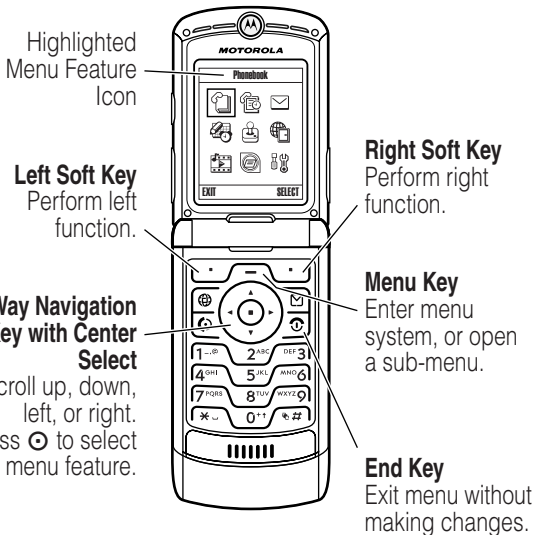



# Using Menus

From the home screen, press  $\sqrt{-}$  to enter the main menu.



Press  $\odot$  to scroll to and highlight a menu feature icon in the main menu. Press **SELECT** ( $\sqrt{-}$ ) or  $\odot$  to select the highlighted menu feature.

The following icons represent features that may display in the main menu, depending on your service provider and service subscription options.

Menu Icon	Feature	Menu Icon	Feature
	Phonebook		Recent Calls
	Messages		Office Tools
	Games & Apps		Web Access
	Multimedia		IM
	Settings		



Some features require you to select an option from a list.

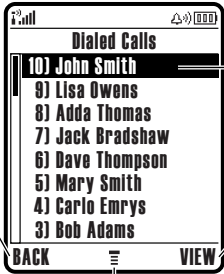



Press **BACK** () to go back to previous screen.

Press **VIEW** () to view details of highlighted option.

Press  to open sub-menu.

Highlighted Option

- Press  to scroll up or down to highlight the option you want.
- In a numbered list, press a number key to highlight the option.

- In an alphabetized list, press a key repeatedly to cycle through the letters on the key and highlight the closest matching list option.
- When an option has a list of possible values, press  left or right to scroll through and select a value.
- When an option has a list of possible numeric values, press a number key to set the value.

## Entering Text

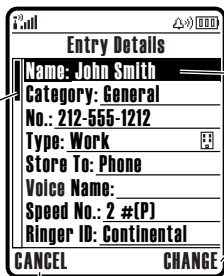

Some features require you to enter information.



Scroll down to bottom of list to view more options.

Highlighted option. Press  to scroll to other options.

Press **CHANGE** () to set or edit highlighted option.

Press **CANCEL** () to exit without making changes. **DONE** () displays when you enter or edit information.

Some features let you enter text.

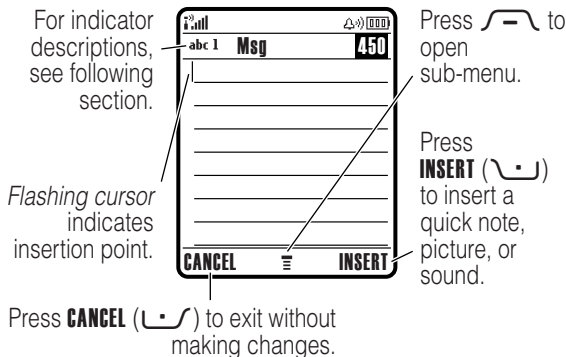

## Selecting a Text Entry Mode

Multiple text entry modes make it easy for you to enter names, numbers, and messages. The mode you select remains active until you select another mode.

Press  $\sqrt{\#}$  in a text entry screen to select one of the following entry modes:

- |                  |  |
|------------------|--|
| <b>Primary</b>   | Your primary text entry mode (see below to set).   |
| <b>Numeric</b>   | Enter numbers only (see page 44).                  |
| <b>Symbol</b>    | Enter symbols only (see page 44).                  |
| <b>Secondary</b> | Your secondary text entry mode (see below to set). |

Alternatively, you can select a text entry mode in any text entry screen by pressing  $\sqrt{-}$  > **Entry Mode**.



## Setting Primary and Secondary Text Entry Modes

You can set different primary and secondary text entry modes, and easily switch between modes as needed when you enter data or compose a message.

Press  > **Entry Setup** in a text entry screen. Select **Primary Setup** or **Secondary Setup**, and choose:

- 
- |                     |  |
|---------------------|--|
| <b>ITAP</b>         | iTAP® software predicts each word as you enter it, to simplify and speed up text entry.  |
| <b>Tap</b>          | Enter individual letters and numbers by pressing a key one or more times.  |
| <b>Tap Extended</b> | Enter individual letters, numbers, and symbols by pressing a key one or more times.  |
| <b>None</b>         | Hide the <b>Secondary</b> setting if you prefer not to set a secondary text entry mode (only available for <b>Secondary Setup</b> ). |

## Using Capitalization

Press  in a text entry screen to change text case. Indicators at the top of the display show the capitalization setting:

abc = no capital letters

ABC = all capital letters

Abc = capitalize next letter only

## Text Entry Mode Indicators

In **Primary** or **Secondary** text entry mode, indicators at the top of the display show the text entry setting:

Primary	Secondary	
1	2	Tap, no capital letters
1↑	2↑	Tap, capitalize next letter only
1↑	2↑	Tap, all capital letters
1	2	iTAP, no capital letters
1↑	2↑	iTAP, capitalize next letter only
1↑	2↑	iTAP, all capital letters

The following indicators identify **Numeric** or **Symbol** entry mode:

123 = numeric mode

@ = symbol mode

## Using iTAP® Mode

iTAP mode lets you enter words using one keypress per letter. The iTAP software combines your keypresses into common words, and predicts each word as you enter it.





For example, to type “the,” you would press

8 TUV / 4 GHI / DEF 3. The iTAP software recognizes that the most common word formed by this keypress combination is “the,” and predicts that “the” is the word you are spelling. Other common words or word fragments that can be spelled by the same keypress combination are presented as alternate choices at the bottom of the display.



If necessary, press  $\sqrt{\ast\#}$  in a text entry screen to switch to **iTAP** mode. An indicator tells you which mode is active (see page 37). If **iTAP** mode is not set as the **Primary** or **Secondary** entry mode, see page 36.

## Entering Words in iTAP Mode

Press	To
1 keypad keys (one press per letter)	show possible letter combinations at the bottom of the display
2  left or right	highlight the combination you want
3  up	accept the predicted word completion, followed by a space
or	
	enter the highlighted combination, followed by a space
or	
<b>SELECT</b> (  )	select the highlighted combination, with no space
	You can press keypad keys to add more letters at the end of the combination.





For example, if you press **7**<sup>PQRS</sup> **7**<sup>PQRS</sup> **6**<sup>MNO</sup> **4**<sup>GHI</sup>, your phone displays:

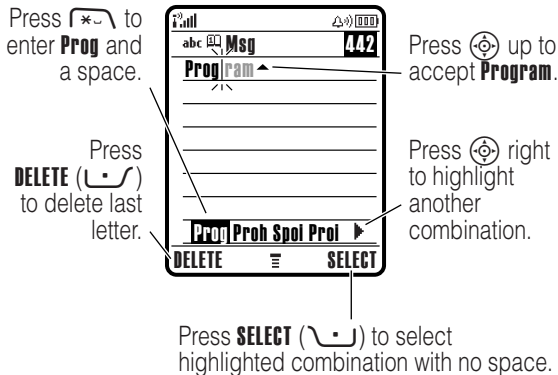

If you want a different word (such as **Progress**), continue pressing keypad keys to enter the remaining characters.

### ***Entering Novel Words in iTAP Mode***

You may enter a word that the iTAP software does not recognize. If your word is not shown as a letter combination choice at the bottom of the display:

#### **Action**

- 1 Press **DELETE** (**↵**) one or more times to delete letters, until you see a letter combination at the bottom of the display that matches the start of the word you want to enter.
- 2 Press **4** left or right to highlight the letter combination.



## Action

- 3 Press **SELECT** () to select the letter combination.
- 4 Continue to enter letters and select letter combinations to spell the word.

Your phone automatically stores the novel word and displays it as an option the next time you enter its letter combination. When the memory space for storing novel words is filled, your phone deletes the oldest words to add new words.



## *Entering Numbers and Punctuation in iTAP Mode*

To enter numbers quickly, press and hold a number key to temporarily switch to numeric mode. Press the number keys to enter the numbers you want. Enter a space to revert to **iTAP** mode.

Press  to enter punctuation or other characters as shown in the “Character Chart” on page 43.

## *Using Tap Mode*

This is the basic text entry mode on your phone.

**Tap** mode cycles through the letters and number of the key you press. **Tap Extended** mode also cycles through additional symbols as shown in the “Character Chart” on page 43.

If necessary, press  in a text entry screen to switch to **Tap** mode. An indicator shows which mode is active (see page 37). If **Tap** or **Tap Extended** is not set as the **Primary** or **Secondary** entry mode, see page 36.

## Tap Mode Text Entry Rules

- Press a keypad key repeatedly to cycle through its characters. For example, you would press  $\sqrt{2^{ABC}}$  one time to enter “a,” two times to enter “b,” three times to enter “c,” or four times to enter “2.”
- After 2 seconds, **Tap** mode accepts the character, and the cursor moves to the next position.
- The first character of every sentence is capitalized. If necessary, press  $\odot$  down to change the character to lowercase before the cursor moves to the next position.
- Press  $\odot$  to move the flashing cursor to enter or edit message text.
- If you do not want to save your text or text edits, press  $\odot$  to exit without saving.



## Entering Words in Tap Mode

	Press	To
1	a keypad key one or more times	enter a letter, number, or symbol
2	keypad keys	enter remaining characters
		<b>Tip:</b> Press $\odot$ right to accept a word completion, or $\sqrt{* \sim}$ to insert a space.
3	OK ( $\sqrt{\_}$ )	store the text

For example, if you press **8<sup>TUV</sup>** one time, your phone displays:

Character displays at insertion point.

Press **DELETE** (**↵**) to delete last character entered.

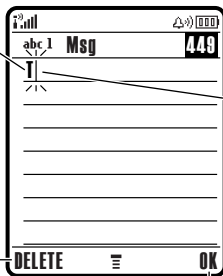

After 2 seconds, character is accepted and cursor moves to next position.

Press **OK** (**↵**) to accept and store text.

When you enter 3 or more characters in a row, your phone may guess the rest of the word. For example, if you enter **prog** your phone might display:



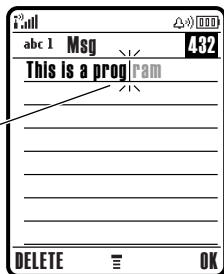









Press **⊙** right to accept **program**. Press **\*↵** to reject it and enter a space after **prog**.



To enter a different word (such as **progress**), press keys to enter remaining characters.

## Character Chart

Use this chart as a guide for entering characters with **Tap Extended** mode.

	. 1 ? ! , @ _ & ~ : ; " - ( ) ' ¿ ¡ % £ \$ ¥ ¤ € + x * / \ [ ] = > < # §
	a b c 2 ä å á à â ã α β ç
	d e f 3 δ ë é è ê φ
	g h i 4 ï í î γ
	j k l 5 λ
	m n o 6 ñ ö ø ó ò ô õ ω
	p q r s 7 π β σ
	t u v 8 θ ü ú ù û
	w x y z 9 ξ ψ
	<i>change text case, for capital letters</i>
	<i>enter a space (hold to enter a return)</i>
	<i>change text entry mode (hold for default)</i>

**Note:** This chart may not reflect the exact character set available on your phone. In an email or Web address editor,  first shows common characters for that editor.





## Using Numeric Mode

In a text entry screen, press  $\sqrt{*\#}$  to switch entry modes until the numeric indicator **123** displays.

Press the number keys to enter the numbers you want. When you finish entering numbers, press  $\sqrt{*\#}$  to switch to another entry mode.

## Using Symbol Mode

In a text entry screen, press  $\sqrt{*\#}$  to switch entry modes until the symbol indicator **@** displays.

	Press	To
1	keypad keys (one press per symbol)	show possible symbol combinations at the bottom of the display
2	 left or right	highlight the combination you want
3	<b>SELECT</b> (  )	select the highlighted combination
		You can press keypad keys to add more symbols to the end of the combination.
	<b>or</b>	
		enter the highlighted combination

## Symbol Chart

Use this chart as a guide for entering characters with symbol mode.

	. ? ! , @ _ & ~ : ; " - ( ) ' ` ;   % £ \$ ¥ ¤ €
	@ _ \
	/ : ;
	" & '
	( ) [ ] { }
	¿ ¡ ~
	< > =
	\$ £ ¥ ¤ €
	# % *
	+ - x * / = > < # §
	<i>enter a space (hold to enter a return)</i>
	<i>change text entry mode (hold for default)</i>

**Note:** This chart may not reflect the exact character set available on your phone. In an email or Web address editor, first shows common characters for that editor.

## Deleting Letters and Words

Place the cursor to the right of the text you want to delete, and then:

### Action

Press **DELETE** () to delete one letter at a time.

Hold **DELETE** () to delete all entered text.



## Using the Smart Key

The *smart key* gives you another way to perform many basic phone functions. It anticipates the next action you are likely to perform. For example, when you highlight a menu item, you can press the smart key to select it. You can use the smart key to make and end calls, turn features on and off, and open your phonebook. The smart key usually performs the same function as the right soft key .

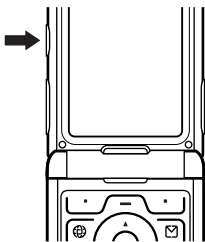

## Using the External Display

When the flip is closed, the external display shows time and phone status information. It also displays messages to notify you of incoming calls and other events. You can perform the following functions in the external display.

### Setting Phone Ring Style

Press	To
1 volume keys	select <b>Ring Styles</b>
2 smart key	set a ring style
3 volume keys	return to the home screen



## Returning an Unanswered Call



Your phone keeps a record of your unanswered calls and displays **X Missed Calls** in the external display.

**Note:** Because the microphone and earpiece are unavailable when the phone is closed, you must use a headset or other handsfree device with this feature.

### Action

- 1 Press the smart key to display the received calls list.

**or**

Press the volume keys to dismiss the **Missed Calls** message.

- 2 If necessary, press the volume keys to scroll through the list and highlight an unanswered call.
- 3 If a headset is connected to your phone, press and hold the smart key to call the number.

**or**

Press the smart key to exit without calling.



## Using the Handsfree Speaker

When you activate your phone's integrated handsfree speaker, you can talk to the other party without holding the phone to your ear.

Press **SPEAKER** (🔊) to turn the handsfree speaker on or off during a call.

Your phone displays **Spkrphone On** in the home screen. The handsfree speaker remains on until you press **SPEAKER** (🔊) again or end the call.

**Note:** The handsfree speaker is disabled when you connect your phone to a handsfree car kit or headset accessory.

## Changing a Code, PIN, or Password

Your phone's 4-digit unlock code is originally set to 1234, and the 6-digit security code is originally set to 000000. Your service provider may reset these codes before you receive your phone.

If your service provider has **not** reset these codes, we recommend that you change them to prevent others from accessing your personal information. The unlock code must contain 4 digits, and the security code must contain 6 digits.

You can also reset your SIM card PIN code, PIN2 code, and/or call barring password if necessary.



To change a code or password:

**Find the Feature**      > **Settings** > **Security**  
> **New Passwords**

## ***Locking and Unlocking Your Phone***

You can lock your phone manually or set the phone to lock automatically whenever you turn it off.

To use a locked phone, you must enter the unlock code. A locked phone still rings or vibrates for incoming calls or messages, **but you must unlock it to answer.**

You can make emergency calls on your phone even when it is locked (see page 68).

### ***Locking Your Phone Manually***

**Find the Feature**      > **Settings** > **Security**  
> **Phone Lock** > **Lock Now**

<b>Press</b>	<b>To</b>
<b>1</b> keypad keys	enter your unlock code
<b>2</b> <b>OK</b> (  )	lock the phone

### ***Unlocking Your Phone***

**Tip:** Your phone's unlock code is originally set to 1234. Your service provider may reset the unlock code to the last 4 digits of your phone number.



At the **Enter Unlock Code** prompt:

Press	To
1 keypad keys	enter your unlock code
2 <b>OK</b> (↵)	unlock your phone

## Setting Your Phone to Lock Automatically

You can set your phone to lock every time you turn it off:



### Find the Feature



↵ > **Settings** > **Security**  
> **Phone Lock**  
> **Automatic Lock** > **On**

Press	To
1 keypad keys	enter your unlock code
2 <b>OK</b> (↵)	activate automatic lock

## If You Forget a Code, PIN, or Password

**Note:** Your phone's 4-digit unlock code is originally set to 1234, and the 6-digit security code is originally set to 000000. Your service provider may reset the unlock code to the last 4 digits of your phone number before you receive your phone.

If you forget your unlock code, try entering 1234 or the last 4 digits of your phone number. If that does not work, do the following at the **Enter Unlock Code** prompt:



Press	To
1 	display the unlock code bypass screen
2 keypad keys	enter your security code
3 <b>OK</b> (  )	submit your security code

If you forget your security code, SIM card PIN code, PIN2 code, or call barring password, contact your service provider.

## ***Using the Phonebook***

This section describes basic phonebook operations. For more information about using the phonebook, see page 76.

### ***Storing a Phone Number***

Enter a phone number in the home screen, then press **STORE** () to create a phonebook entry with that number. Press **DONE** () to store the number by itself, or fill in the other fields as necessary to complete the entry.

If you assign a **Name** to the phonebook entry, you can select **MORE** to store another number (for example, a work number) for the same **Name**.



## ***Recording a Voice Name***

When creating a phonebook entry, scroll to **Voice Name** and press **RECORD** (⏺). Press and release the voice key and say the entry's name (within 2 seconds). When prompted, press and release the voice key and repeat the name.

**Note:** This option is not available for entries stored on the SIM card.



## ***Setting a Picture ID for a Phonebook Entry***

Press  $\sqrt{-}$  > **Phonebook** > *entry*, press  $\sqrt{-}$  > **Edit** > **Picture** > *picture name*.

Also see pages 2 and 16.

## ***Dialing a Number***

Press  $\sqrt{-}$  > **Phonebook**, highlight the phonebook entry, press  $\odot$  to call.

**Shortcut:** In the phonebook, press a keypad key one or more times to jump to entries that begin with the key's letters.

## ***Voice Dialing a Number***

Press and release the voice key, and say the entry's name (within 2 seconds).

## Sorting Phonebook Entries

Press  $\sqrt{-}$  > **Phonebook**, press  $\sqrt{-}$  > **Setup** > **Sort by**, then select whether you want to sort the phonebook list by **Name**, **Speed No.**, **Voice Name**, or **Email**.

When sorting by name, you can view **All** numbers or just the **Primary** number for each name. To set the primary number for a name, see page 79.

**Tip:** In **Primary** number view mode, highlight a name and press  $\odot$  left or right to view other numbers associated with the name.

## Viewing Entries By Category

Press  $\sqrt{-}$  > **Phonebook**, press  $\sqrt{-}$  > **Categories**, then select whether you want to view **All** entries, entries in a predefined category (**Business**, **Personal**, **General**, **VIPs**), or entries in a category you created.

To set the category for a phonebook entry, see page 78.



# Setting Up Your Phone

---

## Setting a Ring Style

You can set the following ring style profiles on your phone:

- **Loud**
- **Soft**
- **Vibrate**
- **Vibe then Ring**
- **Vibe & Ring**
- **Silent**

Each profile uses a different set of ring tone alerts or vibration alerts to notify you of incoming calls, text messages, and other events. The **Silent** setting silences your phone until you set another ring style.

To set a ring style:

**Find the Feature**

 > **Settings** > **Ring Styles**  
> **Style** > *style name*

The ring style indicator shows the current ring style setting (see page 30).









## Changing the Call Alert

You can change the alert that a ring style uses to notify you of incoming calls or other events. Any changes you make are saved to the ring style profile.

**Find the Feature**      > **Settings** > **Ring Styles**  
> **Style Detail**

**Note:** *Style* represents the current ring style. You cannot set an alert for the **Silent** ring style setting.

	Press	To
1		scroll to <b>Calls</b> (or <b>Line 1</b> or <b>Line 2</b> for dual line phones)
2	<b>CHANGE</b> (  )	select the event
3		scroll to the alert you want
4	<b>SELECT</b> (  )	select the alert
5	<b>BACK</b> (  )	save the alert setting

The ring style profile contains additional settings for other events, and settings for ringer ID, ringer and keypad volume. You can change ring style profile settings as desired to personalize the ring style.

## Setting the Time and Date

You must set the time and date to use the datebook.

**Find the Feature**      > **Settings** > **Initial Setup**  
> **Time and Date**











# Setting a Wallpaper Image

Set a photo, picture, or animation as a wallpaper (background) image in your phone's home screen. The wallpaper image appears as a faint watermark in text and menu displays.

## Find the Feature

 > **Settings** > **Personalize**  
> **Wallpaper**

Press	To
1 	scroll to <b>Picture</b>
2 <b>CHANGE</b> (  )	open the picture viewer
3  up or down	scroll to a picture/animation  Scroll to <b>(None)</b> to turn off the wallpaper image.
4 <b>SELECT</b> (  )	select the image
5 	scroll to <b>Layout</b>
6 <b>CHANGE</b> (  )	adjust the image layout
7 	scroll to <b>Center</b> , <b>Tile</b> , or <b>Fit-to-screen</b>  <b>Center</b> places the image in the center of the display.  <b>Tile</b> fills the display with adjacent copies of the image.  <b>Fit-to-screen</b> resizes the image, if necessary, to fit the display.
8 <b>SELECT</b> (  )	confirm the layout setting
9 <b>BACK</b> (  )	save wallpaper settings











# Setting a Screen Saver Image

Set a photo, picture, or animation as a screen saver image. The screen saver image displays when the flip is open and no activity is detected for a specified time. If necessary, the image shrinks to fill the display. An animation repeats for 1 minute, then the first frame of the animation displays.

**Tip:** Turn off the screen saver to extend battery life.

## Find the Feature

 > **Settings** > **Personalize**  
> **Screen Saver**

Press	To
1 	scroll to <b>Picture</b>
2 <b>CHANGE</b> (  )	open the picture viewer
3  up or down	scroll to a picture/animation  Scroll to <b>(None)</b> to turn off the screen saver image.
4 <b>SELECT</b> (  )	select the image
5 	scroll to <b>Delay</b>
6 <b>CHANGE</b> (  )	set the delay interval
7 	scroll to the inactivity interval that starts the screen saver
8 <b>SELECT</b> (  )	select the inactivity interval
9 <b>BACK</b> (  )	save screen saver settings



# Changing Phone Skin

Change the look and feel of your phone's user interface by selecting a different skin setting.

## Find the Feature

 > **Settings** > **Personalize**  
> **Skin** > *skin*

Your phone displays the new skin.

# Setting a Phone Theme



A *phone theme* is of a grouped set of image and sound files with a specific theme (such as a special event or cartoon character) that you can apply collectively to your phone. Phone themes

typically include a wallpaper image, screen saver image, and ring tone. Your phone includes several preloaded themes. You can download and install additional themes on your phone.





## Downloading a Theme

To download a theme from a Web page with the micro-browser, see page 93. When you install the theme, you can instantly apply its screen saver, wallpaper, and ring tone when your phone prompts you to **Apply Theme Now?**

## Selecting a Theme

You can apply any of the themes installed on your phone.



Press	To
1 	scroll to <b>Multi-Key</b> or <b>Open to Answer</b>
2 <b>CHANGE</b> (  )	select the option
3 	scroll to <b>On</b> or <b>Off</b>
4 <b>SELECT</b> (  )	confirm the setting

## Setting Display Brightness

**Find the Feature**

 > **Settings** > **Initial Setup**  
> **Brightness**

## Adjusting the Backlight

Set the amount of time that the display backlight remains on.

**Find the Feature**

 > **Settings** > **Initial Setup**  
> **Backlight**

Your phone's display normally is visible only when the display backlight is on, or when the display is viewed in direct sunlight. To extend battery life, the backlight turns off automatically when no activity is detected for a specified time. The backlight turns back on when you open the flip or press any key.



# Calling Features

For basic instructions on how to make and answer calls, see page 14.

## Turning Off a Call Alert

You can turn off your phone's incoming call alert before answering the call.

### Action

- 1 Press the volume keys to turn off the alert.
- 2 Open the flip (or press the button on a handsfree headset) to answer the call.

## Viewing Recent Calls

Your phone keeps lists of incoming and outgoing calls, even for calls that did not connect. The most recent calls are listed first. The oldest calls are deleted as new calls are added.



**Shortcut:** Press  from the home screen to view the dialed calls list.

### Find the Feature

 > Recent Calls





### Press

### To

- |   |   |  |
|---|---|--|
| 1 |                    | scroll to <b>Received Calls</b> or <b>Dialed Calls</b> |
| 2 | <b>SELECT</b> (  ) | select the list  |





Press	To
3 	scroll to an entry
<b>Note:</b> ✓ means the call connected.	
4 	call the entry's number
or	
VIEW (  )	view entry details (such as time and date of call)
or	
	open the <b>Last Calls Menu</b> to perform other procedures

The **Last Calls Menu** can include the following options:

Option	Description
<b>Store</b>	Create a phonebook entry with the number in the <b>No.</b> field.
<b>Delete</b>	Delete the entry.
<b>Delete All</b>	Delete all entries in the list.
<b>Hide ID/Show ID</b>	Hide or show your caller ID for the next call.
<b>Send Message</b>	Open a new text message with the number in the <b>To</b> field.
<b>Add Digits</b>	Add digits after the number.
<b>Attach Number</b>	Attach a number from the phonebook or recent calls lists.



Option	Description
<b>Send Tones</b>	Send the number to the network as DTMF tones.  <b>Note:</b> This option displays only during a call.
<b>Talk then Fax</b>	Talk and then send a fax in the same call (see page 87).



## Redialing a Number

Press	To
1	view the dialed calls list
2	scroll to the entry you want to call
3	redial the number

## Using Automatic Redial



When you receive a busy signal, your phone displays **Call Failed, Number Busy**.



Press	To
or <b>RETRY</b> (↵)	redial the number

When the call goes through, your phone rings or vibrates one time, displays **Redial Successful**, and connects the call.

# Returning an Unanswered Call

Your phone keeps a record of your unanswered calls, and displays:

- the missed call indicator 
- **X Missed Calls**, where **X** is the number of missed calls

Press	To
1 <b>VIEW</b> (⏪)	display the received calls list
2 	select a call to return
3 	make the call



## Using the Notepad

The most recent set of digits entered on the keypad are stored in your phone's *notepad* memory. This can be a phone number that you called, or a number that you jot down during a call, for later use. To retrieve the number stored in the notepad:



**Find the Feature**

 > **Recent Calls** > **Notepad**



Press	To
	call the number
or	
<b>STORE</b> (  )	create a phonebook entry with the number in the <b>No.</b> field
or	
	open the <b>Dialing Menu</b> to attach a number or insert a special character





## Putting a Call On Hold or Mute

Press	To
 > <b>Hold</b>	put all active calls on hold
or	
 > <b>Mute</b>	mute all active calls

## Using Call Waiting



When you are on a call, an alert tone sounds to indicate that you have received a second call.

Press	To
1 	answer the new call
2 <b>SWITCH</b> (  )	switch between calls
or	
<b>LINK</b> (  )	connect the 2 calls
or	
 > <b>End Call On Hold</b>	end the call on hold

If necessary, you must turn on call waiting to use the feature. To turn call waiting on or off:

**Find the Feature**     > **Settings** > **In-Call Setup**  
> **Call Waiting**

## Using Caller ID (Incoming Calls)



*Calling line identification* (caller ID) displays the phone number for incoming calls in your phone's external and internal displays.

The phone displays the caller's name (and picture ID, if available) when the name is stored in your phonebook, or **Incoming Call** when caller ID information is not available.

You can also set your phone to play a distinctive ringer ID for specific entries stored in your phonebook. For more information, see page 76.



# Calling an Emergency Number

Your service provider programs one or more emergency phone numbers, such as 911 or 112, that you can call under any circumstances, even when your phone is locked or the SIM card is not inserted.

**Note:** Emergency numbers vary by country. Your phone's preprogrammed emergency number(s) may not work in all locations, and sometimes an emergency call cannot be placed due to network, environmental, or interference issues.

	Press	To
1	keypad keys	dial the emergency number
2		call the emergency number

## Dialing International Numbers



If your phone service includes international dialing, press and hold  to insert the local international access code (+) for the country from which you are calling.



(Inserting + enables your phone to make an international call.) Then press the keypad keys as usual to dial the country code and phone number.

## Calling With 1-Touch Dial

To call phonebook entries 1 through 9, press and hold the single-digit speed dial number for one second.

You can set 1-touch dial to call the entries in your phone memory phonebook or the SIM card phonebook:

**Find the Feature**       > **Settings** > **Initial Setup**  
> **1-Touch Dial**

<b>Press</b>	<b>To</b>
1 	scroll to the location you want
2 <b>SELECT</b> (  )	select the location

## Using Voicemail



Voicemail messages that you receive are stored on the network. To listen to your messages, you must call your voicemail phone number.

**Note:** Your service provider may include additional information about using this feature.

### Listening to Voicemail Messages

**Find the Feature**       > **Voicemail**

The phone calls your voicemail phone number. If no voicemail number is stored, your phone prompts you to store a number.



## Receiving a Voicemail Message

When you receive a voicemail message, your phone displays the voicemail message indicator  and the **New Voicemail** notification.

Press	To
CALL (📞)	listen to the message

The phone calls your voicemail phone number. If no voicemail number is stored, your phone prompts you to store a number.

## Storing Your Voicemail Number

If necessary, use the following procedure to store your voicemail phone number on your phone. Usually, your service provider has already done this for you.

**Find the Feature**        > **Voicemail Setup**

Press	To
1 keypad keys	enter your voicemail number
2 OK (📞)	store the number

**Note:** You cannot store a **p** (pause), **w** (wait), or **n** (number) character in this number. If you want to store a voicemail number with these characters, create a phonebook entry for it. Then, you can use the entry to call your voicemail. For more information about these characters, see the *More Here* guide.





# Changing the Active Line



Change the active phone line to make and receive calls from your other phone number.

**Note:** This feature is available only for dual-line-enabled SIM cards.

## Find the Feature

 > **Settings** > **Phone Status**  
> **Active Line**

The call status indicator in the display shows the currently active phone line (see page 29).



# Phone Features

## Main Menu

This is the standard main menu layout. **Menu organization and feature names may vary on your phone.** Not all features may be available on your phone.



### Phonebook



### Recent Calls

- Received Calls
- Dialed Calls
- Notepad
- Call Times
- Call Cost
- Data Times
- Data Volumes



### Messages

- Create Message
- Email Msgs
- Message Inbox
- Voice Mail
- Browser Msgs
- Info Services
- Quick Notes
- Outbox
- Drafts
- MMS Templates



### Office Tools

- SIM Apps
- Calculator
- Datebook
- Shortcuts
- Voice Records
- Alarm Clock
- Dialing Services
  - Fixed Dial
  - Service Dial
  - Quick Dial
- Chat



### Games & Apps



### Web Access

- Browser
- Web Shortcuts
- Stored Pages
- History
- Go To URL
- Browser Setup
- Web Sessions



### Multimedia

- Themes
- Camera
- Pictures
- Sounds
- MotoMixer
- Videos



### IM \*



### Settings

(see next page)

\* The IM feature may not be activated on your phone.

# Settings Menu



## Personalize

- Home Screen
- Main Menu
- Skin
- Greeting
- Wallpaper
- Screen Saver
- Quick Dial



## Ring Styles

- Style
- Style Detail



## Connection

- Bluetooth Link
- Sync



## Call Forward

- Voice Calls
- Fax Calls
- Data Calls
- Cancel All
- Forward Status



## In-Call Setup

- In-Call Timer
- Call Cost Setup
- My Caller ID
- Talk and Fax
- Answer Options
- Call Waiting



## Initial Setup

- Time and Date
- 1-Touch Dial
- Display Timeout
- Backlight
- TTY Setup
- Scroll
- Language
- Brightness
- DTMF
- Master Reset
- Master Clear



## Phone Status

- My Tel. Numbers
- Credit Info/Available
- Active Line
- Battery Meter
- Other Information



## Headset

- Auto Answer
- Voice Dial



## Car Settings

- Auto Answer
- Auto Handsfree



## Network

- New Network
- Network Setup
- Available Networks
- My Network List
- Service Tone
- Call Drop Tone



## Security

- Phone Lock
- Lock Application
- Fixed Dial
- Call Barring
- SIM PIN
- New Passwords
- Certificate Mgmt



## Java Settings









- Java System
- Delete All Apps
- App Vibration
- App Volume
- App Priority
- App Backlight
- Set Standby App
- DNS IP









# Feature Quick Reference







This section helps you locate and use additional phone features that are not described in detail in this guide.

## Calling Features







Feature	Description
<b>Conference Call</b>	During a call: Dial next number, press  , press <b>LINK</b> (  )
<b>Transfer a Call</b>	During a call:  > <b>Transfer</b> , dial transfer number, press  .
<b>Caller ID (Outgoing)</b>	Hide or show your caller ID phone number for the next outgoing call:  > <b>Settings</b> > <b>In-Call Setup</b> > <b>My Caller ID.</b> > <b>Next Call Only</b> > <b>Hide ID</b> or <b>Show ID</b>
<b>Attach a Number</b>	Dial an area code or prefix for a phonebook number, then:  > <b>Attach Number</b>
<b>Speed Dial</b>	Speed dial and call a phonebook entry: Enter speed dial number, press  , press  .

Feature	Description
<b>Call Forwarding</b>	Set up or cancel call forwarding:  > <b>Settings</b> > <b>Call Forward</b> 
<b>Call Barring</b>	Restrict outgoing or incoming calls:  > <b>Settings</b> > <b>Security</b> > <b>Call Barring</b> 
<b>TTY Calls</b>	Set up your phone for use with an optional TTY device:    > <b>Settings</b> > <b>Initial Setup</b> > <b>TTY Setup</b>

## Messages







Feature	Description
<b>Send Text Message</b>	Send a text message:  > <b>Create Message</b> > <b>New Short Message</b> 
<b>Send Multimedia Message</b>	Send a multimedia message:  > <b>Create Message</b> > <b>New Multimedia Msg</b> 
<b>Send Letter</b>	Send a multimedia letter:  > <b>Create Message</b> > <b>New Letter</b> 











Feature	Description
<b>Use MMS Template</b>	Open an MMS template with preloaded media:  > <b>MMS Templates</b> 
<b>Read New Message</b>	Read a new text or multimedia message that you have received: Press <b>READ</b> (↵) when the <b>New Message</b> notification is displayed. 
<b>Read Old Messages</b>	Read received messages:  > <b>Message Inbox</b> <b>Tip:</b> Press ↵ to perform various operations on the message. 
<b>Store Message Objects</b>	Go to a multimedia message page, or highlight an object in a letter, then: ↵ > <b>Store</b> 

## Phonebook

Feature	Description
<b>Add New Entry</b>	Add a new entry to the phonebook: ↵ > <b>Phonebook</b> ↵ > <b>New</b> > <b>Phone Number</b> or <b>Email Address</b>

Feature	Description
<b>Dial Number</b>	Call a number stored in the phonebook:  > <b>Phonebook</b> , highlight the phonebook entry, press  to call
<b>Voice Dial Number</b>	Voice dial a number stored in the phonebook: Press and release the voice key, and say the entry's name (within 2 seconds).
<b>Set Ringer ID for Entry</b>	Assign a distinctive ringer alert to an entry:  > <b>Phonebook</b> > <i>entry</i>  > <b>Edit</b> > <b>Ringer ID</b> > <i>ringer name</i>  <b>Note:</b> The <b>Ringer ID</b> option is not available for entries stored on the SIM card.  To activate ringer IDs, see page 80.
<b>Set Picture ID for Entry</b>	Assign a photo or picture to display when you receive a call from an entry:  > <b>Phonebook</b> > <i>entry</i>  > <b>Edit</b> > <b>Picture</b> > <i>picture name</i>  <b>Note:</b> The <b>Picture</b> option is not available for entries stored on the SIM card.









Feature	Description
<b>Set Picture ID View</b>	View phonebook entries as a text list, or with picture caller ID photos:  > <b>Phonebook</b>  > <b>Setup</b> > <b>View by</b> > <i>view name</i>
<b>Set Category for Entry</b>	Set the category for an entry:  > <b>Phonebook</b> > <i>entry</i>  > <b>Edit</b> > <b>Category</b> > <i>category name</i>  <b>Note:</b> The <b>Category</b> option is not available for entries stored on the SIM card.
<b>Set Category View</b>	Set a category view:  > <b>Phonebook</b>  > <b>Categories</b> > <i>category view</i>
<b>Set Category Ringer ID</b>	Set a distinctive ring alert (ringer ID) to sound when you receive calls from entries in a specific category:  > <b>Phonebook</b>  > <b>Categories</b> , highlight the category, press  > <b>Edit</b> > <b>Ringer ID</b> .  <b>Note:</b> The <b>Ringer ID</b> option is not available for entries stored on the SIM card.  To activate ringer IDs, see page 80.







Feature	Description
<b>Sort Phonebook List</b>	Set the order in which entries are listed: ↵ > <b>Phonebook</b> ↵ > <b>Setup</b> > <b>Sort by</b> > <i>sort order</i>
<b>Set Primary Number or Address</b>	Set the primary number for an entry with multiple numbers: ↵ > <b>Phonebook</b> , highlight the entry, press ↵ > <b>Set Primary</b> > <i>number or address</i> .
<b>Copy Phonebook Entry</b>	Copy an entry between the phone and SIM card: ↵ > <b>Phonebook</b> , highlight the entry, press ↵ > <b>Copy</b> > <b>Entries</b> > <b>To</b>
<b>Send Phonebook Entry to Another Device</b>	Send a phonebook entry to another phone, computer, or device: ↵ > <b>Phonebook</b> , highlight the entry, press ↵ > <b>Send</b>
<b>Create Group Mailing List</b>	Create a group mailing list as a phonebook entry: ↵ > <b>Phonebook</b> ↵ > <b>New</b> > <b>Mailing List</b>





# Personalizing Features

Feature	Description
<b>Activate Ringer IDs</b>	Activate ringer IDs assigned to phonebook entries and categories:  > <b>Settings</b> > <b>Ring Styles</b> > <b>Style Detail</b> > <b>Ringer IDs</b>
<b>Ring Volume</b>	Set ringer volume:  > <b>Settings</b> > <b>Ring Styles</b> > <b>Style Detail</b> > <b>Ring Volume</b>
<b>Keypad Volume</b>	Set keypad keypress volume:  > <b>Settings</b> > <b>Ring Styles</b> > <b>Style Detail</b> > <b>Key Volume</b>
<b>Reminders</b>	Set reminder alerts for messages that you receive:  > <b>Settings</b> > <b>Ring Styles</b> > <b>Style Detail</b> > <b>Reminders</b>
<b>Clock View</b>	Display an analog clock or digital time readout in the home screen:  > <b>Settings</b> > <b>Personalize</b> > <b>Home Screen</b> > <b>Clock</b>
<b>Menu View</b>	Display the main menu as graphic icons or as a text-based list:  > <b>Settings</b> > <b>Personalize</b> > <b>Main Menu</b> > <b>View</b>
<b>Main Menu</b>	Reorder your phone's main menu:  > <b>Settings</b> > <b>Personalize</b> > <b>Main Menu</b> > <b>Reorder</b>

Feature	Description
<b>Show or Hide Menu Icons</b>	Show or hide menu feature icons in the home screen:  > <b>Settings</b> > <b>Personalize</b> > <b>Home Screen</b> > <b>Home Keys</b> > <b>Icons</b>
<b>Change Menu Icons &amp; Home Keys</b>	Change menu feature icons, soft key labels, and smart key function in the home screen:  > <b>Settings</b> > <b>Personalize</b> > <b>Home Screen</b> > <b>Home Keys</b>
<b>Shortcuts</b>	Create a shortcut to a menu item: Highlight the menu item, then press and hold  .  Use a shortcut: Press  , then press the shortcut number.

## Instant Messaging \*

Feature	Description	
<b>Log In</b>	Log in to instant messaging:  > <b>IM</b> > <b>Log In</b>	
<b>Find Others Online</b>	After you sign on: Select <b>Contact List</b> to see a list of other users.	

\* The IM feature may not be activated on your phone.



Feature	Description
<b>Start Conversation</b>	Start a conversation: From your <b>Contact List</b> , highlight a name in <b>Online Contacts</b> , press <b>SEND IM</b> (⏏).
<b>Open Active Conversation</b>	Open a conversation in progress: From your <b>Contact List</b> , highlight a name in <b>Conversations</b> , press <b>VIEW</b> (⏏).
<b>End Conversation</b>	From the conversation display: ⏏ > <b>End Conversation</b>
<b>Log Out</b>	Log out of instant messaging: Select <b>Log Out</b> from the <b>IM Online</b> menu.

## Chat



Feature	Description
<b>Start Chat</b>	Start a new chat session: ⏏ > <b>Office Tools</b> > <b>Chat</b> ⏏ > <b>New Chat</b>
<b>Receive Chat Request</b>	When you receive a chat request: Press <b>ACCEPT</b> (⏏) or <b>IGNORE</b> (⏏).

Feature	Description
End Chat	During a chat session:  > <b>End Chat</b> 

## Email

Feature	Description
Send Email Message	Send an email message:  > <b>Create Message</b> > <b>New Email</b> 
Read Email Message	Read a new email message that you have received: Press <b>READ</b> (ر). 





## Menu Features



Feature	Description
Language	Set menu language:  > <b>Settings</b> > <b>Initial Setup</b> > <b>Language</b>
Master Reset	Reset all options <b>except</b> unlock code, security code, and lifetime timer:  > <b>Settings</b> > <b>Initial Setup</b> > <b>Master Reset</b>



Feature	Description
<b>Master Clear</b>	<p>Clear all user settings and entries <b>except</b> SIM card information, erase all downloaded pictures and sound files, reset all options <b>except</b> unlock code, security code, and lifetime timer:</p> <p> &gt; <b>Settings</b> &gt; <b>Initial Setup</b> &gt; <b>Master Clear</b></p> <p><b>Caution:</b> Master clear <b>erases all user-entered information</b> (including phonebook and datebook entries) <b>and user-downloaded content</b> (including photos and sounds) stored in your phone's memory. After you erase the information, you cannot recover it.</p>

## Special Dialing Features

Feature	Description
<b>Fixed Dial</b>	<p>Turn fixed dialing on or off:</p> <p> &gt; <b>Settings</b> &gt; <b>Security</b> &gt; <b>Fixed Dial</b></p> <p>Use the fixed dial list:</p> <p> &gt; <b>Office Tools</b> &gt; <b>Dialing Services</b> &gt; <b>Fixed Dial</b></p> 
<b>Service Dial</b>	<p>Dial service phone numbers:</p> <p> &gt; <b>Office Tools</b> &gt; <b>Dialing Services</b> &gt; <b>Service Dial</b></p> 

Feature	Description
<b>Quick Dial</b>	Dial preprogrammed phone numbers:  > <b>Office Tools</b> > <b>Dialing Services</b> > <b>Quick Dial</b>
<b>DTMF Tones</b>	Activate DTMF tones:  > <b>Settings</b> > <b>Initial Setup</b> > <b>DTMF</b>  Send DTMF tones during a call: Press number keys.  Send stored numbers as DTMF tones during a call: Highlight a number in the phonebook or recent calls lists, then press  > <b>Send Tones</b> .









## Call Monitoring

**Network connection time** is the elapsed time from the moment you connect to your service provider's network to the moment you end the call by pressing . This time includes busy signals and ringing.

The amount of network connection time you track on your resettable timer may not equal the amount of time for which you are billed by your service provider. For





billing information, please contact your service provider directly.





Feature	Description
<b>Call Times</b>	View call timers:  > <b>Recent Calls</b> > <b>Call Times</b> 
<b>In-Call Timer</b>	Display time or cost information during a call:  > <b>Settings</b> > <b>In-Call Setup</b> > <b>In-Call Timer</b> 
<b>Call Cost</b>	View call cost trackers:  > <b>Recent Calls</b> > <b>Call Cost</b> 

## Handsfree Features





**Note:** The use of wireless devices and their accessories may be prohibited or restricted in certain areas. Always obey the laws and regulations on the use of these products.

Feature	Description
<b>Auto Answer</b> (car kit or headset)	Automatically answer calls when connected to a car kit or headset:  > <b>Settings</b> > <b>Car Settings</b> or <b>Headset</b> > <b>Auto Answer</b> 



Feature	Description	
<b>Voice Dial</b> (headset)	Enable voice dial with headset send/end key:  > <b>Settings</b> > <b>Headset</b> > <b>Voice Dial</b>	
<b>Auto Handsfree</b> (car kit)	Automatically route calls to a car kit when connected:  > <b>Settings</b> > <b>Car Settings</b> > <b>Auto Handsfree</b>	











## Data and Fax Calls





Feature	Description	
<b>Send Data or Fax</b>	Connect your phone to the device, then place the call through the device application.	
<b>Receive Data or Fax</b>	Connect your phone to the device, then answer the call through the device application.	
<b>Talk Then Fax</b>	Connect your phone to the device, enter the number, press  > <b>Dialing Menu</b> > <b>Talk Then Fax</b> , then press  to make the call.	



# Bluetooth® Wireless Connections

**Note:** Your phone's Bluetooth features and Bluetooth Class 1 power levels are not allowed for outdoor operation in France. To avoid unlawful interference with radio signals, do not use the Bluetooth features in France unless you are indoors.

Feature	Description	
<b>Make Phone Visible to Other Device</b>	Allow a Bluetooth device to discover your phone:  > <b>Settings</b> > <b>Connection</b> > <b>Bluetooth Link</b> > <b>Setup</b> > <b>Find Me</b>	
<b>Connect to Recognized Device</b>	Connect to a recognized handsfree device:  > <b>Settings</b> > <b>Connection</b> > <b>Bluetooth Link</b> > <b>Handsfree</b> > <i>device name</i>	
<b>Disconnect From Device</b>	Disconnect from a device: Highlight the device name and press <b>DROP</b> (  .	
<b>Switch to Device During Call</b>	Switch to a headset or car kit during a call:  > <b>Use Bluetooth</b>	
<b>Send Multimedia Object to Device</b>	Send a multimedia object to another device: Highlight the object, press  > <b>Copy</b> , select the device name.	

Feature	Description
<b>Move Multimedia Object to Device</b>	<p>Move a multimedia object to another device:            Highlight the object, press  &gt; <b>Move</b>, select the device name.</p> <p><b>Caution:</b> Moving an object <b>deletes</b> the original object from your phone.</p>
<b>Send Data to Another Device</b>	<p>Copy a phonebook entry, datebook event, or bookmark to another device:            Highlight the item, press  &gt; <b>Send</b>.</p>
<b>Edit Device Properties</b>	<p>Edit the properties of a recognized device:            Highlight the device name and press  &gt; <b>Edit</b>.</p>
<b>Set Bluetooth Options</b>	<p>Set your phone's Bluetooth options:   &gt; <b>Settings</b> &gt; <b>Connection</b> &gt; <b>Bluetooth Link</b> &gt; <b>Setup</b></p>























## Network Features

Feature	Description
<b>Network Settings</b>	<p>View network information and adjust network settings:   &gt; <b>Settings</b> &gt; <b>Network</b></p>



# Personal Organizer Features



Feature	Description
<b>Set Alarm</b>	Set an alarm:  > <b>Office Tools</b> > <b>Alarm Clock</b>
<b>Turn Off Alarm</b>	Turn off alarm: Press <b>DISABLE</b> (  ) or  .  Set 8-minute delay: Press <b>SNOOZE</b> (  ).
<b>Add New Datebook Event</b>	Add a new event to the datebook:  > <b>Office Tools</b> > <b>Datebook</b> , highlight the day, press  , press  > <b>New</b>
<b>View Datebook Event</b>	View or edit event details:  > <b>Office Tools</b> > <b>Datebook</b> , highlight the day, press  , highlight the event, press <b>VIEW</b> (  )
<b>Event Reminder</b>	View a datebook event reminder: <b>VIEW</b> (  )  Dismiss an event reminder: <b>EXIT</b> (  )
<b>Send Datebook Event to Another Device</b>	Send a datebook event to another phone, computer, or device:  > <b>Office Tools</b> > <b>Datebook</b> , highlight the day, press  , highlight the event, press  > <b>Send</b>

Feature	Description
<b>Create Voice Record</b>	<p>Create a voice record: Press and hold voice key, speak into the phone, release voice key</p> <p><b>Note:</b> Recording phone calls is subject to varying state and federal laws regarding privacy and recording of conversations.</p>
<b>Play Voice Record</b>	<p>Play back a voice record:   &gt; <b>Office Tools</b> &gt; <b>Voice Records</b>            &gt; <i>voice record</i></p>
<b>Calculator</b>	<p>Calculate numbers:   &gt; <b>Office Tools</b> &gt; <b>Calculator</b></p>
<b>Currency Converter</b>	<p>Convert currency:   &gt; <b>Office Tools</b> &gt; <b>Calculator</b>   &gt; <b>Exchange Rate</b></p> <p>Enter exchange rate, press <b>OK</b> ()            enter amount, press   &gt; <b>Convert Currency</b>.</p>







## Security





Feature	Description
<b>SIM PIN</b>	<p>Lock or unlock the SIM card:   &gt; <b>Settings</b> &gt; <b>Security</b> &gt; <b>SIM PIN</b></p> <p><b>Caution:</b> If you enter an incorrect PIN code 3 times in a row, your SIM card is disabled and your phone displays <b>SIM Blocked</b>.</p>



Feature	Description
<b>Lock Application</b>	Lock phone applications:  > <b>Settings</b> > <b>Security</b> > <b>Lock Application</b>
<b>Certificate Management</b>	Enable or disable security certificates stored on your phone:  > <b>Settings</b> > <b>Security</b> > <b>Certificate Mgmt</b>

## News and Entertainment

Feature	Description
<b>Manage Pictures</b>	Manage pictures and animations:  > <b>Multimedia</b> > <b>Pictures</b> 
<b>Manage Sounds</b>	Manage ring tones and music that you have downloaded or composed:  > <b>Multimedia</b> > <b>Sounds</b>
<b>Manage Video Clips</b>	Manage video clips:  > <b>Multimedia</b> > <b>Videos</b>
<b>Edit Sounds With MotoMixer</b>	Edit MIDI-based songs that you can use with your phone:  > <b>Multimedia</b> > <b>MotoMixer</b> > <b>[New Mix]</b> or <i>mix file name</i>
<b>Start Micro-Browser</b>	Start a micro-browser session: Press  

Feature	Description
<b>Download Objects from Web Page</b>	Download a picture, sound, or phone theme from a Web page: Highlight the file, press <b>SELECT</b> (↵), press <b>STORE</b> (⏏). 
<b>Web Sessions</b>	Select or create a Web session: ↵ > <b>Web Access</b> > <b>Web Sessions</b> 
<b>Download Game or Application</b>	Download a Java™ game or application with the micro-browser: ↵ > <b>Web Access</b> > <b>Browser</b> , highlight the application, press <b>SELECT</b> (↵), press <b>DOWNLOAD</b> (⏏) 
<b>Start Game or Application</b>	Start a Java game or application: ↵ > <b>Games &amp; Apps</b> , highlight the application, press <b>SELECT</b> (↵) 
<b>Play Music</b>	Play a song on your phone: ↵ > <b>Multimedia</b> > <b>Sounds</b> > <i>song name</i>
<b>Create Playlist</b>	Create a playlist of songs to play on your phone: ↵ > <b>Multimedia</b> > <b>Sounds</b> > <b>[New Playlist]</b>



<b>Feature</b>	<b>Description</b>
<b>Create Ring Tones</b>	Create iMelody ring tones that you can use with your phone:  > <b>Multimedia</b> > <b>Sounds</b> > <b>[New iMelody]</b>



# Troubleshooting

---

If you have questions or need help, we're here to help.

Go to [www.motorola.com/consumer/support](http://www.motorola.com/consumer/support), where you can select from a number of customer care options. You can also contact the Motorola Customer Support Center at 1-800-331-6456 (United States), 1-888-390-6456 (TTY/TDD United States for hearing impaired), or 1-800-461-4575 (Canada).



# ***Specific Absorption Rate Data***

---

## **The model wireless phone meets the government's requirements for exposure to radio waves.**

Your wireless phone is a radio transmitter and receiver. It is designed and manufactured not to exceed limits for exposure to radio frequency (RF) energy set by the Federal Communications Commission (FCC) of the U.S. Government and by the Canadian regulatory authorities. These limits are part of comprehensive guidelines and establish permitted levels of RF energy for the general population. The guidelines are based on standards that were developed by independent scientific organizations through periodic and thorough evaluation of scientific studies. The standards include a substantial safety margin designed to assure the safety of all persons, regardless of age or health.

The exposure standard for wireless mobile phones employs a unit of measurement known as the Specific Absorption Rate, or SAR. The SAR limit set by the FCC and by the Canadian regulatory authorities is 1.6 W/kg.<sup>1</sup> Tests for SAR are conducted using standard operating positions accepted by the FCC and by Industry Canada with the phone transmitting at its highest certified power level in all tested frequency bands. Although the SAR is determined at the highest certified power level, the actual SAR level of the phone while operating can be well below the maximum value. This is because the phone is designed to operate at multiple power levels so as to use only the power required to reach the network. In general, the closer you are to a wireless base station, the lower the power output.

Before a phone model is available for sale to the public in the U.S. and Canada, it must be tested and certified to the FCC and Industry Canada that it does not exceed the limit established by each government for safe exposure. The tests are performed in positions and locations (e.g., at the ear and worn on the body) reported to the FCC and available for review by Industry Canada. The highest SAR value for this model phone when

tested for use at the ear is 0.89 W/kg, and when worn on the body, as described in this user guide, is 0.58 W/kg. The SAR value for this product in its data transmission mode (body-worn use) is 1.24 W/kg. (Body-worn measurements differ among phone models, depending upon available accessories and regulatory requirements).<sup>2</sup>

While there may be differences between the SAR levels of various phones and at various positions, they all meet the governmental requirements for safe exposure. Please note that improvements to this product model could cause differences in the SAR value for later products; in all cases, products are designed to be within the guidelines.

Additional information on Specific Absorption Rates (SAR) can be found on the Cellular Telecommunications & Internet Association (CTIA) Web site:

<http://www.phonefacts.net>

or the Canadian Wireless Telecommunications Association (CWTA) Web site:

<http://www.cwta.ca>

1. In the United States and Canada, the SAR limit for mobile phones used by the public is 1.6 watts/kg (W/kg) averaged over one gram of tissue. The standard incorporates a substantial margin of safety to give additional protection for the public and to account for any variations in measurements.
2. The SAR information includes the Motorola testing protocol, assessment procedure, and measurement uncertainty range for this product.

# European Union Directives Conformance Statement

---



[France Only]

Hereby, Motorola declares that this product is in compliance with:

- The essential requirements and other relevant provisions of Directive 1999/5/EC
- All other relevant EU Directives



The above gives an example of a typical Product Approval Number.

You can view your product's Declaration of Conformity (DoC) to Directive 1999/5/EC (the R&TTE Directive) at [www.motorola.com/rtte](http://www.motorola.com/rtte) - to find your DoC, enter the product Approval Number from your product's label in the "Search" bar on the Web site.

# Index

---

## A

- accessories 9, 47, 75, 86, 87, 88
- accessory connector port 1
- active line indicator 29
- active line, changing 71
- alarm clock 90
- alert
  - creating 94
  - defined 54
  - reminder 80
  - setting 14, 46, 54, 55
  - turning off 14, 62
- animation 19, 56, 57, 92
- answering a call 15, 59
- attach number 63, 74

## B

- backlight 60
- barring calls 75
- battery 11
- battery level indicator 30
- battery life, extending 10, 23, 27, 57, 60, 61
- Bluetooth connection
  - indicator 2, 28

## Bluetooth wireless

- connection 3, 23, 79, 88, 90

brightness 60

browser. See micro-browser

## C

calculator 91

call

- alert, turning off 14, 62
  - answering 15, 59
  - barring 75
  - costs 86
  - dialing 14, 52, 77
  - emergency number 68
  - ending 14, 15
  - forwarding 75
  - hold 66
  - international dialing 68
  - making 14, 52, 77
  - mute 66
  - receiving 15
  - returning 47, 65
  - talk then fax 64
  - timers 86
  - transferring 74
- call barring password 48

- Call Failed, Number Busy message 64
- call forward indicator 29
- call waiting 66
- caller ID 3, 17, 52, 63, 67, 74, 77
- camera 2, 16
- car kit 86
- center select key 1, 31
- certificate management 92
- character chart 43
- chat 82
- clock 26, 55, 80
- codes 48, 49, 50
- conference call 74
- CSD indicator 28
- cursor 35
- customer support 95

## **D**

- data call 87
- data transmission indicator 28
- date, setting 55
- datebook 90
- dialed calls 62
- dialing a phone number 14, 52, 77, 84, 85
- display
  - backlight 60
  - brightness 60

- language 83
- personalizing 80, 81
- skin 58
- timeout 61
- using 26
- download media objects 76, 93
- drafts folder 22
- DTMF tones 64, 85

## **E**

- earpiece volume 14
- email 83
- email address, storing 76
- emergency number 68
- end key 1, 14, 15
- ending a call 14, 15
- Enter Unlock Code message 50, 51
- external display 2, 46

## **F**

- fax call 64, 87
- fixed dial 84
- flip 15, 17, 46, 59
- forwarding calls 75

## **G**

- games 93
- GPRS indicator 29
- group mailing list 79

## H

handsfree speaker 48  
handsfree use 86  
headset 47, 86  
Hide ID feature 63  
hold call 66  
home keys 81  
home screen 26

## I

IM 26, 81  
IM indicators 30  
in-call indicator 29  
Incoming Call message 67  
indicators 26, 28, 29, 30,  
37, 65, 70  
instant messaging. *See* IM  
international access code  
68  
iTAP text entry mode 37

## J

Java applications 93  
Java midlet indicator 30

## K

keypad 59, 80  
keys 1, 8, 13, 14, 15, 27,  
31, 46, 47, 81

## L

language 83  
left soft key 1, 27, 81  
line, changing 71  
lock  
    application 92  
    phone 49  
    SIM card 91  
Low Battery message 30

## M

making a call 14, 52, 77  
master clear 84  
master reset 83  
menu  
    entering text 34  
    language 83  
    navigating 32  
    personalizing 80, 81  
    selecting feature 33  
menu icons 26, 33, 80, 81  
menu indicator 26  
menu key 1, 8  
message 26, 75, 76, 80  
message indicator 30  
message key 1, 31  
micro-browser 26, 92, 93  
missed call indicator 65  
Missed Calls message 47,  
65  
MMS, defined 19

MotoMixer 92  
multimedia letter 75  
multimedia message 3, 19,  
75, 76  
music 92, 93  
mute call 66  
my telephone number 15,  
61

## N

navigation key 1, 8, 31  
network settings 89  
notepad 65  
number. *See* phone number  
numeric entry mode 44

## O

object exchange 25  
1-touch dial 68  
open to answer 59  
operator key 1, 31  
optional accessory 9  
optional feature 9

## P

passwords. *See* codes  
phone  
illustration 1, 2  
turning on/off 13  
unlocking 49, 50

phone number  
active line, changing 71  
redialing 64  
storing in phonebook 76  
storing your number 61  
viewing your number 15  
phone theme 58  
phonebook 26, 51, 63, 68,  
74

photo 2, 3, 16, 19, 52, 56,  
57, 77, 92  
picture 19, 56, 57, 92  
picture ID 3, 17, 52, 67, 77  
PIN code 48, 91  
PIN2 code 48  
playlist 93  
power key 1, 13  
predictive text entry 37

## Q

quick dial 85

## R

received calls 62  
recent calls 26, 62, 63  
redial 64  
reminders 80  
right soft key 1, 27, 81  
ring style indicators 30  
ring style, setting 14, 46, 54  
ring tone 92, 93, 94



ringer ID 67, 77, 78, 80  
ringer volume 14, 80  
roam indicator 29

## S

screen saver 57  
security code 48, 50  
send key 1, 14, 15  
service dial 84  
shortcuts 81  
Show ID feature 63  
signal strength indicator 29  
SIM Blocked message 13,  
91  
SIM card  
installing 9  
locking 91  
PIN code 48, 91  
PIN2 code 48  
precautions 9  
service dial 84  
skin 58  
smart key 1, 2, 17, 46, 47,  
81  
soft keys 1, 27, 81  
song 92, 93  
sound 19, 92, 93, 94  
speakerphone 86  
speed dial 74  
Spkrphone On message 48

symbol chart 45  
symbol entry mode 44

## T

talk then fax call 64  
tap text entry mode 40  
telephone number. *See*  
phone number  
text entry 34  
text indicators 37  
theme 58  
time, setting 55  
timers 86  
transfer a call 74  
travel charger 12  
troubleshooting 95  
TTY device 75  
turning on/off 13

## U

unanswered call 47, 65  
unlock  
application 92  
phone 49  
unlock code 48, 49, 50

## V

video clip 19, 92  
voice dial 52, 77, 87  
voice key 1, 52  
voice name, recording 52

voice record 19, 91  
voicemail 69  
voicemail message indicator  
    30, 70  
volume  
    earpiece 14  
    keypad 80  
    ringer 14, 80  
volume keys 1, 14, 46, 47

## **W**

wallpaper 56  
Web pages 92  
Web sessions 93





***MOTOROLA***

***IMPORTANT SAFETY AND LEGAL  
INFORMATION >***

## Software Copyright Notice

The Motorola products described in this manual may include copyrighted Motorola and third party software stored in semiconductor memories or other media. Laws in the United States and other countries preserve for Motorola and third party software providers certain exclusive rights for copyrighted software, such as the exclusive rights to distribute or reproduce the copyrighted software. Accordingly, any copyrighted software contained in the Motorola products may not be modified, reverse-engineered, distributed, or reproduced in any manner to the extent allowed by law. Furthermore, the purchase of the Motorola products shall not be deemed to grant either directly or by implication, estoppel, or otherwise, any license under the copyrights, patents, or patent applications of Motorola or any third party software provider, except for the normal, non-exclusive, royalty-free license to use that arises by operation of law in the sale of a product.

# Contents

---

<b>Safety and General Information</b> . . . . .	4
<b>FDA Consumer Information on Wireless Phones</b> . . . . .	10
<b>Product Registration</b> . . . . .	20
<b>RF Energy Interference</b> . . . . .	20
<b>Export Law Assurances</b> . . . . .	20
<b>Wireless: The New Recyclable</b> . . . . .	21
<b>Wireless Phone Safety Tips</b> . . . . .	23

# ***Safety and General Information***

---

IMPORTANT INFORMATION ON SAFE AND EFFICIENT OPERATION.  
READ THIS INFORMATION BEFORE USING YOUR PHONE.

The information provided in this document supersedes the general safety information in user's guides published prior to December 1, 2002.

## ***Exposure To Radio Frequency (RF) Energy***

Your phone contains a transmitter and a receiver. When it is ON, it receives and transmits RF energy. When you communicate with your phone, the system handling your call controls the power level at which your phone transmits.

Your Motorola phone is designed to comply with local regulatory requirements in your country concerning exposure of human beings to RF energy.

## ***Operational Precautions***

To assure optimal phone performance and make sure human exposure to RF energy is within the guidelines set forth in the relevant standards, always adhere to the following procedures.

### ***External Antenna Care***

Use only the supplied or Motorola-approved replacement antenna. Unauthorized antennas, modifications, or attachments could damage the phone.

Do NOT hold the external antenna when the phone is IN USE. Holding the external antenna affects call quality and may cause the phone to operate at a higher power level than needed. In addition, use of unauthorized antennas may result in non-compliance with the local regulatory requirements in your country.

## ***Phone Operation***

When placing or receiving a phone call, hold your phone as you would a wireline telephone.

## ***Body-Worn Operation***

To maintain compliance with RF energy exposure guidelines, if you wear a phone on your body when transmitting, always place the phone in a Motorola-supplied or approved clip, holder, holster, case, or body harness for this phone, if available. Use of accessories not approved by Motorola may exceed RF energy exposure guidelines. If you do not use one of the body-worn accessories approved or supplied by Motorola, and are not using the phone held in the normal use position, ensure the phone and its antenna are at least 1 inch (2.5 centimeters) from your body when transmitting.

## ***Data Operation***

When using any data feature of the phone, with or without an accessory cable, position the phone and its antenna at least 1 inch (2.5 centimeters) from your body.

## ***Approved Accessories***

Use of accessories not approved by Motorola, including but not limited to batteries and antennas, may cause your phone to exceed RF energy exposure guidelines. For a list of approved Motorola accessories, visit our website at [www.Motorola.com](http://www.Motorola.com).

## ***RF Energy Interference/Compatibility***

**Note:** Nearly every electronic device is susceptible to RF energy interference from external sources if inadequately shielded, designed, or otherwise configured for RF energy compatibility. In some circumstances your phone may cause interference.



## ***Facilities***

Turn off your phone in any facility where posted notices instruct you to do so. These facilities may include hospitals or health care facilities that may be using equipment that is sensitive to external RF energy.

## ***Aircraft***

When instructed to do so, turn off your phone when on board an aircraft. Any use of a phone must be in accordance with applicable regulations per airline crew instructions.

## ***Medical Devices***

### **Pacemakers**

Pacemaker manufacturers recommend that a minimum separation of 6 inches (15 centimeters) be maintained between a handheld wireless phone and a pacemaker.

Persons with pacemakers should:

- ALWAYS keep the phone more than 6 inches (15 centimeters) from your pacemaker when the phone is turned ON.
- NOT carry the phone in the breast pocket.
- Use the ear opposite the pacemaker to minimize the potential for interference.
- Turn OFF the phone immediately if you have any reason to suspect that interference is taking place.

### **Hearing Aids**

Some digital wireless phones may interfere with some hearing aids. In the event of such interference, you may want to consult your hearing aid manufacturer to discuss alternatives.

### **Other Medical Devices**

If you use any other personal medical device, consult the manufacturer of your device to determine if it is adequately shielded from RF energy. Your physician may be able to assist you in obtaining this information.

## ***Use While Driving***

Check the laws and regulations on the use of phones in the area where you drive. Always obey them.

When using your phone while driving, please:

- Give full attention to driving and to the road.
- Use handsfree operation, if available.
- Pull off the road and park before making or answering a call if driving conditions so require.

Responsible driving best practices may be found in the “Wireless Phone Safety Tips” at the end of this manual and at the Motorola website: [www.Motorola.com/callsmart](http://www.Motorola.com/callsmart).

## ***Operational Warnings***

### ***For Vehicles With an Air Bag***

Do not place a phone in the area over an air bag or in the air bag deployment area. Air bags inflate with great force. If a phone is placed in the air bag deployment area and the air bag inflates, the phone may be propelled with great force and cause serious injury to occupants of the vehicle.

### ***Potentially Explosive Atmospheres***

Turn off your phone prior to entering any area with a potentially explosive atmosphere. Do not remove, install, or charge batteries in such areas. Sparks in a potentially explosive atmosphere can cause an explosion or fire resulting in bodily injury or even death.

**Note:** The areas with potentially explosive atmospheres referred to above include fueling areas such as below decks on boats, fuel or chemical transfer or storage facilities, areas where the air contains chemicals or particles, such as grain, dust, or metal powders. Areas with potentially explosive atmospheres are often but not always posted.





## ***Blasting Caps and Areas***

To avoid possible interference with blasting operations, turn OFF your phone when you are near electrical blasting caps, in a blasting area, or in areas posted "Turn off electronic devices." Obey all signs and instructions.

## ***Batteries***

Batteries can cause property damage and/or bodily injury such as burns if a conductive material such as jewelry, keys, or beaded chains touch exposed terminals. The conductive material may complete an electrical circuit (short circuit) and become quite hot. Exercise care in handling any charged battery, particularly when placing it inside a pocket, purse, or other container with metal objects. **Use only Motorola original batteries and chargers.**

Your battery or phone may contain symbols, defined as follows:

<b>Symbol</b>	<b>Definition</b>
	Important safety information will follow.
	Your battery or phone should not be disposed of in a fire.
	Your battery or phone may require recycling in accordance with local laws. Contact your local regulatory authorities for more information.
	Your battery or phone should not be thrown in the trash.
	Your phone contains an internal lithium ion battery.

## ***Seizures/Blackouts***

Some people may be susceptible to epileptic seizures or blackouts when exposed to flashing lights, such as when watching television or playing

video games. These seizures or blackouts may occur even if a person never had a previous seizure or blackout.

If you have experienced seizures or blackouts, or if you have a family history of such occurrences, please consult with your doctor before playing video games on your phone or enabling a flashing-lights feature on your phone. (The flashing-light feature is not available on all products.)

Parents should monitor their children's use of video game or other features that incorporate flashing lights on the phones. All persons should discontinue use and consult a doctor if any of the following symptoms occur: convulsion, eye or muscle twitching, loss of awareness, involuntary movements, or disorientation.

To limit the likelihood of such symptoms, please take the following safety precautions:

- Do not play or use a flashing-lights feature if you are tired or need sleep.
- Take a minimum of a 15-minute break hourly.
- Play in a room in which all lights are on.
- Play at the farthest distance possible from the screen.

## ***Repetitive Motion Injuries***

When you play games on your phone, you may experience occasional discomfort in your hands, arms, shoulders, neck, or other parts of your body. Follow these instructions to avoid problems such as tendonitis, carpal tunnel syndrome, or other musculoskeletal disorders:

- Take a minimum 15-minute break every hour of game playing.
- If your hands, wrists, or arms become tired or sore while playing, stop and rest for several hours before playing again.
- If you continue to have sore hands, wrists, or arms during or after play, stop playing and see a doctor.

# **FDA Consumer Information on Wireless Phones**

---



The U.S. Food and Drug Administration (FDA) provides consumer information on wireless phones at:

<http://www.fda.gov/cellphones/qa.html>

Following are safety-related questions and answers discussed at this web site.

## ***Do wireless phones pose a health hazard?***

The available scientific evidence does not show that any health problems are associated with using wireless phones. There is no proof, however, that wireless phones are absolutely safe. Wireless phones emit low levels of radio frequency energy (RF) in the microwave range while being used. They also emit very low levels of RF when in the stand-by mode. Whereas high levels of RF can produce health effects (by heating tissue), exposure to low level RF that does not produce heating effects causes no known adverse health effects. Many studies of low level RF exposures have not found any biological effects. Some studies have suggested that some biological effects may occur, but such findings have not been confirmed by additional research. In some cases, other researchers have had difficulty in reproducing those studies, or in determining the reasons for inconsistent results.

## ***What is FDA's role concerning the safety of wireless phones?***

Under the law, FDA does not review the safety of radiation-emitting consumer products such as wireless phones before they can be sold, as it does with new drugs or medical devices. However, the agency has authority to take action if wireless phones are shown to emit radio

frequency energy (RF) at a level that is hazardous to the user. In such a case, FDA could require the manufacturers of wireless phones to notify users of the health hazard and to repair, replace or recall the phones so that the hazard no longer exists.

Although the existing scientific data do not justify FDA regulatory actions, FDA has urged the wireless phone industry to take a number of steps, including the following:

- Support needed research into possible biological effects of RF of the type emitted by wireless phones;
- Design wireless phones in a way that minimizes any RF exposure to the user that is not necessary for device function; and
- Cooperate in providing users of wireless phones with the best possible information on possible effects of wireless phone use on human health.

FDA belongs to an interagency working group of the federal agencies that have responsibility for different aspects of RF safety to ensure coordinated efforts at the federal level. The following agencies belong to this working group:

- National Institute for Occupational Safety and Health
- Environmental Protection Agency
- Federal Communications Commission
- Occupational Safety and Health Administration
- National Telecommunications and Information Administration

The National Institutes of Health participates in some interagency working group activities, as well.

FDA shares regulatory responsibilities for wireless phones with the Federal Communications Commission (FCC). All phones that are sold in the United States must comply with FCC safety guidelines that limit RF exposure. FCC relies on FDA and other health agencies for safety questions about wireless phones.

FCC also regulates the base stations that the wireless phone networks rely upon. While these base stations operate at higher power than do the wireless phones themselves, the RF exposures that people get from these base stations are typically thousands of times lower than those they can get from wireless phones. Base stations are thus not the primary subject of the safety questions discussed in this document.

## ***What is FDA doing to find out more about the possible health effects of wireless phone RF?***

FDA is working with the U.S. National Toxicology Program and with groups of investigators around the world to ensure that high priority animal studies are conducted to address important questions about the effects of exposure to radio frequency energy (RF).

FDA has been a leading participant in the World Health Organization International Electromagnetic Fields (EMF) Project since its inception in 1996. An influential result of this work has been the development of a detailed agenda of research needs that has driven the establishment of new research programs around the world. The Project has also helped develop a series of public information documents on EMF issues.

FDA and the Cellular Telecommunications & Internet Association (CTIA) have a formal Cooperative Research and Development Agreement (CRADA) to do research on wireless phone safety. FDA provides the scientific oversight, obtaining input from experts in government, industry, and academic organizations. CTIA-funded research is conducted through contracts to independent investigators. The initial research will include both laboratory studies and studies of wireless phone users. The CRADA will also include a broad assessment of additional research needs in the context of the latest research developments around the world.

## ***What steps can I take to reduce my exposure to radio frequency energy from my wireless phone?***

If there is a risk from these products--and at this point we do not know that there is--it is probably very small. But if you are concerned about avoiding even potential risks, you can take a few simple steps to minimize your exposure to radio frequency energy (RF). Since time is a key factor in how much exposure a person receives, reducing the amount of time spent using a wireless phone will reduce RF exposure.

If you must conduct extended conversations by wireless phone every day, you could place more distance between your body and the source of the RF, since the exposure level drops off dramatically with distance. For example, you could use a headset and carry the wireless phone away from your body or use a wireless phone connected to a remote antenna

Again, the scientific data do not demonstrate that wireless phones are harmful. But if you are concerned about the RF exposure from these products, you can use measures like those described above to reduce your RF exposure from wireless phone use.

## ***What about children using wireless phones?***

The scientific evidence does not show a danger to users of wireless phones, including children and teenagers. If you want to take steps to lower exposure to radio frequency energy (RF), the measures described above would apply to children and teenagers using wireless phones. Reducing the time of wireless phone use and increasing the distance between the user and the RF source will reduce RF exposure.

Some groups sponsored by other national governments have advised that children be discouraged from using wireless phones at all. For example, the government in the United Kingdom distributed leaflets containing such a recommendation in December 2000. They noted that no evidence exists that using a wireless phone causes brain tumors or other ill effects. Their recommendation to limit wireless phone use by children was strictly



precautionary; it was not based on scientific evidence that any health hazard exists.

### ***Do hands-free kits for wireless phones reduce risks from exposure to RF emissions?***

Since there are no known risks from exposure to RF emissions from wireless phones, there is no reason to believe that hands-free kits reduce risks. Hands-free kits can be used with wireless phones for convenience and comfort. These systems reduce the absorption of RF energy in the head because the phone, which is the source of the RF emissions, will not be placed against the head. On the other hand, if the phone is mounted against the waist or other part of the body during use, then that part of the body will absorb more RF energy. Wireless phones marketed in the U.S. are required to meet safety requirements regardless of whether they are used against the head or against the body. Either configuration should result in compliance with the safety limit.

### ***Do wireless phone accessories that claim to shield the head from RF radiation work?***

Since there are no known risks from exposure to RF emissions from wireless phones, there is no reason to believe that accessories that claim to shield the head from those emissions reduce risks. Some products that claim to shield the user from RF absorption use special phone cases, while others involve nothing more than a metallic accessory attached to the phone. Studies have shown that these products generally do not work as advertised. Unlike “hand-free” kits, these so-called “shields” may interfere with proper operation of the phone. The phone may be forced to boost its power to compensate, leading to an increase in RF absorption. In February 2002, the Federal Trade Commission (FTC) *charged two companies* that sold devices that claimed to protect wireless phone users from radiation with making false and unsubstantiated claims. According to FTC, these defendants lacked a reasonable basis to substantiate their claim.

# **Motorola Limited Warranty for the United States and Canada**

---

## **What Does this Warranty Cover?**

Subject to the exclusions contained below, Motorola, Inc. warrants its telephones, pagers, messaging devices, and consumer and professional two-way radios (excluding commercial, government or industrial radios) that operate via Family Radio Service or General Mobile Radio Service, Motorola-branded or certified accessories sold for use with these Products ("Accessories") and Motorola software contained on CD-ROMs or other tangible media and sold for use with these Products ("Software") to be free from defects in materials and workmanship under normal consumer usage for the period(s) outlined below. This limited warranty is a consumer's exclusive remedy, and applies as follows to new Motorola Products, Accessories and Software purchased by consumers in the United States or Canada, which are accompanied by this written warranty:

### **Products and Accessories**

<b>Products Covered</b>	<b>Length of Coverage</b>
<b>Products and Accessories</b> as defined above, unless otherwise provided for below.	<b>One (1) year</b> from the date of purchase by the first consumer purchaser of the product unless otherwise provided for below.
<b>Decorative Accessories and Cases.</b> Decorative covers, bezels, PhoneWrap™ covers and cases.	<b>Limited lifetime warranty</b> for the lifetime of ownership by the first consumer purchaser of the product.

<b>Products Covered</b>	<b>Length of Coverage</b>
<b>Monaural Headsets.</b> Ear buds and boom headsets that transmit mono sound through a wired connection.	<b>Limited lifetime warranty</b> for the lifetime of ownership by the first consumer purchaser of the product.
<b>Consumer and Professional Two-Way Radio Accessories.</b>	<b>Ninety (90) days</b> from the date of purchase by the first consumer purchaser of the product.
<b>Products and Accessories that are Repaired or Replaced.</b>	<b>The balance of the original warranty or for ninety (90) days</b> from the date returned to the consumer, whichever is longer.

### ***Exclusions***

**Normal Wear and Tear.** Periodic maintenance, repair and replacement of parts due to normal wear and tear are excluded from coverage.

**Batteries.** Only batteries whose fully charged capacity falls below 80% of their rated capacity and batteries that leak are covered by this limited warranty.

**Abuse & Misuse.** Defects or damage that result from: (a) improper operation, storage, misuse or abuse, accident or neglect, such as physical damage (cracks, scratches, etc.) to the surface of the product resulting from misuse; (b) contact with liquid, water, rain, extreme humidity or heavy perspiration, sand, dirt or the like, extreme heat, or food; (c) use of the Products or Accessories for commercial purposes or subjecting the Product or Accessory to abnormal usage or conditions; or (d) other acts which are not the fault of Motorola, are excluded from coverage.

**Use of Non-Motorola Products and Accessories.** Defects or damage that result from the use of Non-Motorola branded or certified Products, Accessories, Software or other peripheral equipment are excluded from coverage.

**Unauthorized Service or Modification.** Defects or damages resulting from service, testing, adjustment, installation, maintenance, alteration, or modification in any way by someone other than Motorola, or its authorized service centers, are excluded from coverage.

**Altered Products.** Products or Accessories with (a) serial numbers or date tags that have been removed, altered or obliterated; (b) broken seals or that show evidence of tampering; (c) mismatched board serial numbers; or (d) nonconforming or non-Motorola housings, or parts, are excluded from coverage.

**Communication Services.** Defects, damages, or the failure of Products, Accessories or Software due to any communication service or signal you may subscribe to or use with the Products Accessories or Software is excluded from coverage.

## **Software**

<b>Products Covered</b>	<b>Length of Coverage</b>
<b>Software.</b> Applies only to physical defects in the media that embodies the copy of the software (e.g. CD-ROM, or floppy disk).	<b>Ninety (90) days</b> from the date of purchase.

## **Exclusions**

**Software Embodied in Physical Media.** No warranty is made that the software will meet your requirements or will work in combination with any hardware or software applications provided by third parties, that the operation of the software products will be uninterrupted or error free, or that all defects in the software products will be corrected.

**Software NOT Embodied in Physical Media.** Software that is not embodied in physical media (e.g. software that is downloaded from the internet), is provided “as is” and without warranty.

## **Who is Covered?**

This warranty extends only to the first consumer purchaser, and is not transferable.

## ***What Will Motorola Do?***

Motorola, at its option, will at no charge repair, replace or refund the purchase price of any Products, Accessories or Software that does not conform to this warranty. We may use functionally equivalent reconditioned/refurbished/pre-owned or new Products, Accessories or parts. No data, software or applications added to your Product, Accessory or Software, including but not limited to personal contacts, games and ringer tones, will be reinstalled. To avoid losing such data, software and applications please create a back up prior to requesting service.

## ***How to Obtain Warranty Service or Other Information***

USA	<b>Phones</b> 1-800-331-6456 Pagers 1-800-548-9954 <b>Two-Way Radios and Messaging Devices</b> 1-800-353-2729
Canada	<b>All Products</b> 1-800-461-4575
TTY	<b>TTY</b> 1-888-390-6456
For <b>Accessories</b> and <b>Software</b> , please call the telephone number designated above for the product with which they are used.	

You will receive instructions on how to ship the Products, Accessories or Software, at your expense, to a Motorola Authorized Repair Center. To obtain service, you must include: (a) a copy of your receipt, bill of sale or other comparable proof of purchase; (b) a written description of the problem; (c) the name of your service provider, if applicable; (d) the name and location of the installation facility (if applicable) and, most importantly; (e) your address and telephone number.

## ***What Other Limitations Are There?***

ANY IMPLIED WARRANTIES, INCLUDING WITHOUT LIMITATION THE IMPLIED WARRANTIES OF MERCHANTABILITY AND FITNESS FOR A

PARTICULAR PURPOSE, SHALL BE LIMITED TO THE DURATION OF THIS LIMITED WARRANTY, OTHERWISE THE REPAIR, REPLACEMENT, OR REFUND AS PROVIDED UNDER THIS EXPRESS LIMITED WARRANTY IS THE EXCLUSIVE REMEDY OF THE CONSUMER, AND IS PROVIDED IN LIEU OF ALL OTHER WARRANTIES, EXPRESS OR IMPLIED. IN NO EVENT SHALL MOTOROLA BE LIABLE, WHETHER IN CONTRACT OR TORT (INCLUDING NEGLIGENCE) FOR DAMAGES IN EXCESS OF THE PURCHASE PRICE OF THE PRODUCT, ACCESSORY OR SOFTWARE, OR FOR ANY INDIRECT, INCIDENTAL, SPECIAL OR CONSEQUENTIAL DAMAGES OF ANY KIND, OR LOSS OF REVENUE OR PROFITS, LOSS OF BUSINESS, LOSS OF INFORMATION OR DATA, SOFTWARE OR APPLICATIONS OR OTHER FINANCIAL LOSS ARISING OUT OF OR IN CONNECTION WITH THE ABILITY OR INABILITY TO USE THE PRODUCTS, ACCESSORIES OR SOFTWARE TO THE FULL EXTENT THESE DAMAGES MAY BE DISCLAIMED BY LAW.

**Some states and jurisdictions do not allow the limitation or exclusion of incidental or consequential damages, or limitation on the length of an implied warranty, so the above limitations or exclusions may not apply to you. This warranty gives you specific legal rights, and you may also have other rights that vary from state to state or from one jurisdiction to another.**

Laws in the United States and other countries preserve for Motorola certain exclusive rights for copyrighted Motorola software such as the exclusive rights to reproduce and distribute copies of the Motorola software. Motorola software may only be copied into, used in, and redistributed with, the Products associated with such Motorola software. No other use, including without limitation disassembly of such Motorola software or exercise of the exclusive rights reserved for Motorola, is permitted.

## ***Product Registration***

---

Online Product Registration:

<http://www.motorola.com/warranty>

Product registration is an important step toward enjoying your new Motorola product. Registering helps us facilitate warranty service, and permits us to contact you should your product require an update or other service. Registration is for U.S. residents only and is not required for warranty coverage.

Please retain your original dated sales receipt for your records. For warranty service of your Motorola Personal Communications Product you will need to provide a copy of your dated sales receipt to confirm warranty status.

Thank you for choosing a Motorola product.

## ***RF Energy Interference***

---

This device complies with Part 15 of the FCC Rules. Operation is subject to the following two conditions: (1) this device may not cause harmful interference, and (2) this device must accept any interference received, including interference that may cause undesired operation.

## ***Export Law Assurances***

---

This product is controlled under the export regulations of the United States of America and Canada. The Governments of the United States of America and Canada may restrict the exportation or re-exportation of this product to certain destinations. For further information contact the U.S. Department of Commerce or the Canadian Department of Foreign Affairs and International Trade.

## ***Wireless: The New Recyclable***

---

Your wireless phone can be recycled. Recycling your wireless phone reduces the amount of waste disposed in landfills and allows recycled materials to be incorporated into new products.

The Cellular Telecommunications Industry Association (CTIA) and its members encourage consumers to recycle their phones and have taken steps to promote the collection and environmentally sound recycling of end-of-life wireless devices.

As a wireless phone user, you have an important role in ensuring that this phone is recycled properly. When it comes time to give this phone up or trade it in for a new one, please remember that the phone, the charger, and many of its accessories can be recycled. It's easy. To learn more about CTIA's Recycling Program for Used Wireless Devices in the United States, including information on where to recycle wireless devices near you, please visit [www.recyclewirelessphones.com](http://www.recyclewirelessphones.com).







**MOTOROLA**

# **Wireless Phone Safety Tips**

*“Safety is your most important call!”*

Your Motorola wireless telephone gives you the powerful ability to communicate by voice—almost anywhere, anytime, wherever wireless phone service is available and safe conditions allow. But an important responsibility accompanies the benefits of wireless phones, one that every user must uphold.

When driving a car, driving is your first responsibility. If you find it necessary to use your wireless phone while behind the wheel of a car, practice good common sense and remember the following tips:

- 1 Get to know your Motorola wireless phone and its features such as speed dial and redial.** If available, these features help you to place your call without taking your attention off the road.



- 2 **When available, use a hands-free device.** If possible, add an additional layer of convenience to your wireless phone with one of the many Motorola Original™ hands-free accessories available today.
- 3 **Position your wireless phone within easy reach.** Be able to access your wireless phone without removing your eyes from the road. If you receive an incoming call at an inconvenient time, if possible, let your voice mail answer it for you.
- 4 **Let the person you are speaking with know you are driving; if necessary, suspend the call in heavy traffic or hazardous weather conditions.** Rain, sleet, snow, ice, and even heavy traffic can be hazardous.
- 5 **If you receive an incoming call at an inconvenient time do not take notes or look up phone numbers while driving.** Jotting down a “to do” list or going through your address book takes attention away from your primary responsibility—driving safely.
- 6 **Dial sensibly and assess the traffic; if possible, place calls when you are not moving or before pulling into traffic.** Try to plan calls when your car will be stationary. If you need to make a call while moving, dial only a few numbers, check the road and your mirrors, then continue.
- 7 **Do not engage in stressful or emotional conversations that may be distracting.** Make people you are talking with aware you are driving and suspend conversations which have the potential to divert your attention away from the road.

- 
- 8 **Use your wireless phone to call for help.** Dial 9-1-1 or other local emergency number in the case of fire, traffic accident or medical emergencies.\*
- 9 **Use your wireless phone to help others in emergencies.** If you see an auto accident, crime in progress or other serious emergency where lives are in danger, call 9-1-1 or other local emergency number, as you would want others to do for you.\*
- 10 **Call roadside assistance or a special non-emergency wireless assistance number when necessary.** If you see a broken-down vehicle posing no serious hazard, a broken traffic signal, a minor traffic accident where no one appears injured, or a vehicle you know to be stolen, call roadside assistance or other special non-emergency wireless number.\*

\* Wherever wireless phone service is available.

**Check the laws and regulations on the use of wireless telephones and their accessories in the areas where you drive. Always obey them. The use of these devices may be prohibited or restricted in certain areas.**



For more information,  
please call  
1-888-901-SAFE  
or visit the  
CTIA Web site at  
[www.wow-com.com](http://www.wow-com.com)<sup>TM</sup>



