



Some of the contents in this manual may differ from your phone depending on the software of the phone or your service provider.

BL20 User Guide



Congratulations on your purchase of the advanced and compact BL20 phone by LG, designed to operate with the latest digital mobile communication technology.

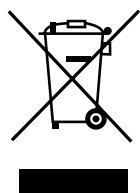

Disposal of your old appliance

- 1** When this crossed-out wheeled bin symbol is attached to a product it means the product is covered by the European Directive 2002/96/EC.
- 2** All electrical and electronic products should be disposed of separately from the municipal waste stream via designated collection facilities appointed by the government or the local authorities.
- 3** The correct disposal of your old appliance will help prevent potential negative consequences for the environment and human health.
- 4** For more detailed information about disposal of your old appliance, please contact your city office, waste disposal service or the shop where you purchased the product.

Contents

Guidelines for safe and efficient use	5	Messaging	22
Getting to know your phone	11	Messaging	22
Open view	12	Sending a message	22
Installing the SIM and battery	13	Entering text	23
Memory card	14	Message folders	24
Installing a memory card	14	Managing your messages	24
Removing the memory card	14	Using templates	25
Formatting the memory card	14	Camera	26
Your standby screen	15	Taking a quick photo	26
The quick keys	15	After you've taken your photo	26
The main menu	15	Getting to know the viewfinder	27
The status bar	16	Viewing your saved photos	27
Calls	17	Setting a photo as Wallpaper or Picture ID	27
Making a call	17	Video camera	28
Making a call from your contacts	17	Shooting a quick video	28
Answering and rejecting a call	17	After you've shot your video	28
Adjusting the call volume	17	Watching your saved videos	29
Speed dialling	18	Adjusting the volume when viewing a video	29
Using call divert	18		
Using call barring	19		
Contacts	20		
Searching for a contact	20		
Adding a new contact	20		
Contact options	20		
Adding a contact to a group	21		
Renaming a group	21		

Contents

MP3 player.....	30	Sending and receiving your files using Bluetooth	38
MP3 player	30	Games and Apps.....	40
Transferring music onto your phone	30	Games and Apps	40
Playing a song.....	30	Playing a game.....	40
Creating a playlist.....	31	Browser	41
Playing a playlist.....	31	Accessing the web.....	41
Editing a playlist	31	Adding and accessing your bookmarks	41
Deleting a playlist	32	Saving a page	42
My stuff	33	Accessing a saved page.....	42
Images.....	33	Viewing your browser history	42
Images options menu.....	33	Changing the web browser settings	42
Sending a photo	34	Settings	43
Organising your images	34	Changing your display settings	43
Deleting an image	34	Changing your security settings	43
Deleting multiple images.....	34	Resetting your phone	44
Creating a slide show.....	35	Viewing memory status.....	44
Sounds	35	Changing your Bluetooth settings.....	44
Using a sound	35	Changing your connectivity settings	44
Videos	35	Pairing with another Bluetooth device ..	45
Watching a video	35	Using a Bluetooth headset.....	45
Using options while video is paused	36	Accessories	46
Sending a video clip.....	36	Network service	47
Video options menu	36	Technical data.....	47
External memory	37		
Using your phone as a mass storage device.....	37		
Transferring a file to your phone	38		

Guidelines for safe and efficient use

Please read these simple guidelines. Not following these guidelines may be dangerous or illegal.

Exposure to radio frequency energy

THIS DEVICE MEETS INTERNATIONAL GUIDELINES FOR EXPOSURE TO RADIO WAVES

Your mobile device is a radio transmitter and receiver. It is designed and manufactured not to exceed the limits for exposure to radio frequency (RF) recommended by international guidelines (ICNIRP). These limits are part of comprehensive guidelines and establish permitted levels of RF energy for the general population. The guidelines were developed by independent scientific organisations through periodic and thorough evaluation of scientific studies. The guidelines include a substantial safety margin designed to assure the safety of all persons, regardless of age and health.

The exposure standard for mobile devices employs a unit of measurement known as the Specific Absorption Rate, or SAR. The SAR limit stated in the international guidelines is 2.0 W/kg*. Tests for SAR are conducted using standard operating positions with the device transmitting at its highest certified power level in all tested frequency bands. Although

the SAR is determined at the highest certified power level, the actual SAR of the device while operating can be well below the maximum value. This is because the device is designed to operate at multiple power levels so as to use only the power required to reach the network. In general, the closer you are to a base station, the lower the power output of the device. Before a phone model is available for sale to the public, compliance with the European R&TTE directive must be shown. This directive includes as one essential requirement the protection of the health and the safety for the user and any other person.

The highest SAR value for this device when tested for use at the ear is 0.667 W/kg.

This device meets RF exposure guidelines when used either in the normal use position against the ear or when positioned at least 1.5 cm away from the body. When a carry case, belt clip or holder is used for body-worn operation, it should not contain metal and should position the product at least 1.5 cm away from your body. In order to transmit data files or messages, this device requires a quality connection to the network. In some cases, transmission of data files or messages may be delayed until such a connection is available. Ensure the above separation distance instructions are followed until the

Guidelines for safe and efficient use

transmission is completed. The highest SAR value for this device when tested for use at the body is 1.45 W/kg.

* The SAR limit for mobile devices used by the public is 2.0 watts/kilogram (W/kg) averaged over ten grams of body tissue. The guidelines incorporate a substantial margin of safety to give additional protection for the public and to account for any variations in measurements. SAR values may vary depending on national reporting requirements and the network band.

For SAR information in other regions please look under product information at www.lgmobile.com.

FCC SAR information

Your mobile device is also designed to meet the requirements for exposure to radio waves established by the Federal Communications Commission (USA) and Industry Canada.

These requirements set a SAR limit of 1.6 W/kg averaged over 1 gram of tissue. The highest SAR value reported under this standard during product certification for use at the ear is 0.413 W/kg and when properly worn on the body is 0.578 W/kg.

Additionally, this device was tested for typical body-worn operations with the back of the phone kept 0.79 inches (2cm) between the users body and the back of the phone.

To comply with FCC RF exposure requirements, a minimum separation distance of 0.79 inches(2cm) must be maintained between the user's body and the back of the phone.

* FCC Notice & Caution

Notice!

This device complies with part 15 of the FCC Rules. Operation is subject to the following two conditions:

- (1) This device may not cause harmful interference, and
- (2) this device must accept any interference received, including interference that may cause undesired operation.

Caution!

Change or Modification that are not expressly approved by the manufacturer could void the user's authority to operate the equipment.

Product care and maintenance

WARNING

Only use batteries, chargers and accessories approved for use with this particular phone model. The use of any other types may invalidate any approval or warranty applying to the phone, and may be dangerous.

- Do not disassemble this unit. Take it to a qualified service technician when repair work is required.
- Keep away from electrical appliances such as TVs, radios, and personal computers.
- The unit should be kept away from heat sources such as radiators or cookers.
- Do not drop.
- Do not subject this unit to mechanical vibration or shock.
- Switch off the phone in any area where you are required by special regulations. For example, do not use your phone in hospitals as it may affect sensitive medical equipment.
- Do not handle the phone with wet hands while it is being charged. It may cause an electric shock and can seriously damage your phone.
- Do not to charge a handset near flammable material as the handset can become hot and create a fire hazard.
- Use a dry cloth to clean the exterior of the unit (do not use solvents such as benzene, thinner or alcohol).
- Do not charge the phone when it is on soft furnishings.
- The phone should be charged in a well ventilated area.
- Do not subject this unit to excessive smoke or dust.
- Do not keep the phone next to credit cards or transport tickets; it can affect the information on the magnetic strips.
- Do not tap the screen with a sharp object as it may damage the phone.
- Do not expose the phone to liquid or moisture.
- Use the accessories like earphones cautiously. Do not press the antenna unnecessarily.

Guidelines for safe and efficient use

Efficient phone operation

Electronics devices

All mobile phones may get interference, which could affect performance.

- Do not use your mobile phone near medical equipment without requesting permission. Avoid placing the phone over pacemakers, for example in your breast pocket.
- Some hearing aids might be disturbed by mobile phones.
- Minor interference may affect TVs, radios, PCs, etc.

Road safety

Check the laws and regulations on the use of mobile phones in the areas when you drive.

- Do not use a hand-held phone while driving.
- Give full attention to driving.
- Use a hands-free kit, if available.
- Pull off the road and park before making or answering a call if driving conditions so require.

- RF energy may affect some electronic systems in your vehicle such as car stereos and safety equipment.
- When your vehicle is equipped with an air bag, do not obstruct with installed or portable wireless equipment. It can cause the airbag to fail or cause serious injury due to improper performance.
- If you are listening to music whilst out and about, please ensure that the volume is at a reasonable level so that you are aware of your surroundings. This is particularly imperative when near roads.

Avoid damage to your hearing

Damage to your hearing can occur if you are exposed to loud sound for long periods of time. We therefore recommend that you do not turn on or off the handset close to your ear. We also recommend that music and call volumes are set to a reasonable level.

Blasting area

Do not use the phone where blasting is in progress. Observe restrictions, and follow any regulations or rules.

Potentially explosive atmospheres

- Do not use the phone at a refueling point.
- Do not use near fuel or chemicals.
- Do not transport or store flammable gas, liquid, or explosives in the same compartment of your vehicle as your mobile phone and accessories.

In aircraft

Wireless devices can cause interference in aircraft.

- Turn your mobile phone off before boarding any aircraft.
- Do not use it on the ground without permission from the crew.

Children

Keep the phone in a safe place out of the reach of small children. It includes small parts which may cause a choking hazard if detached.

Emergency calls

Emergency calls may not be available under all mobile networks. Therefore, you should never depend solely on the phone for emergency calls. Check with your local service provider.

Battery information and care

- You do not need to completely discharge the battery before recharging. Unlike other battery systems, there is no memory effect that could compromise the battery's performance.
- Use only LG batteries and chargers. LG chargers are designed to maximize the battery life.
- Do not disassemble or short-circuit the battery pack.
- Keep the metal contacts of the battery pack clean.
- Replace the battery when it no longer provides acceptable performance. The battery pack maybe recharged hundreds of times until it needs replacing.
- Recharge the battery if it has not been used for a long time to maximize usability.

Guidelines for safe and efficient use

- Do not expose the battery charger to direct sunlight or use it in high humidity, such as the bathroom.
- Do not leave the battery in hot or cold places, this may deteriorate the battery performance.
- There is risk of explosion if the battery is replaced by an incorrect type.
- Dispose of used batteries according to the manufacturer's instructions. Please recycle when possible. Do not dispose as household waste.
- If you need to replace the battery, take it to the nearest authorised LG Electronics service point or dealer for assistance.
- Always unplug the charger from the wall socket after the phone is fully charged to save unnecessary power consumption of the charger.
- Actual battery life will depend on network configuration, product settings, usage patterns, battery and environmental conditions.

Getting to know your phone

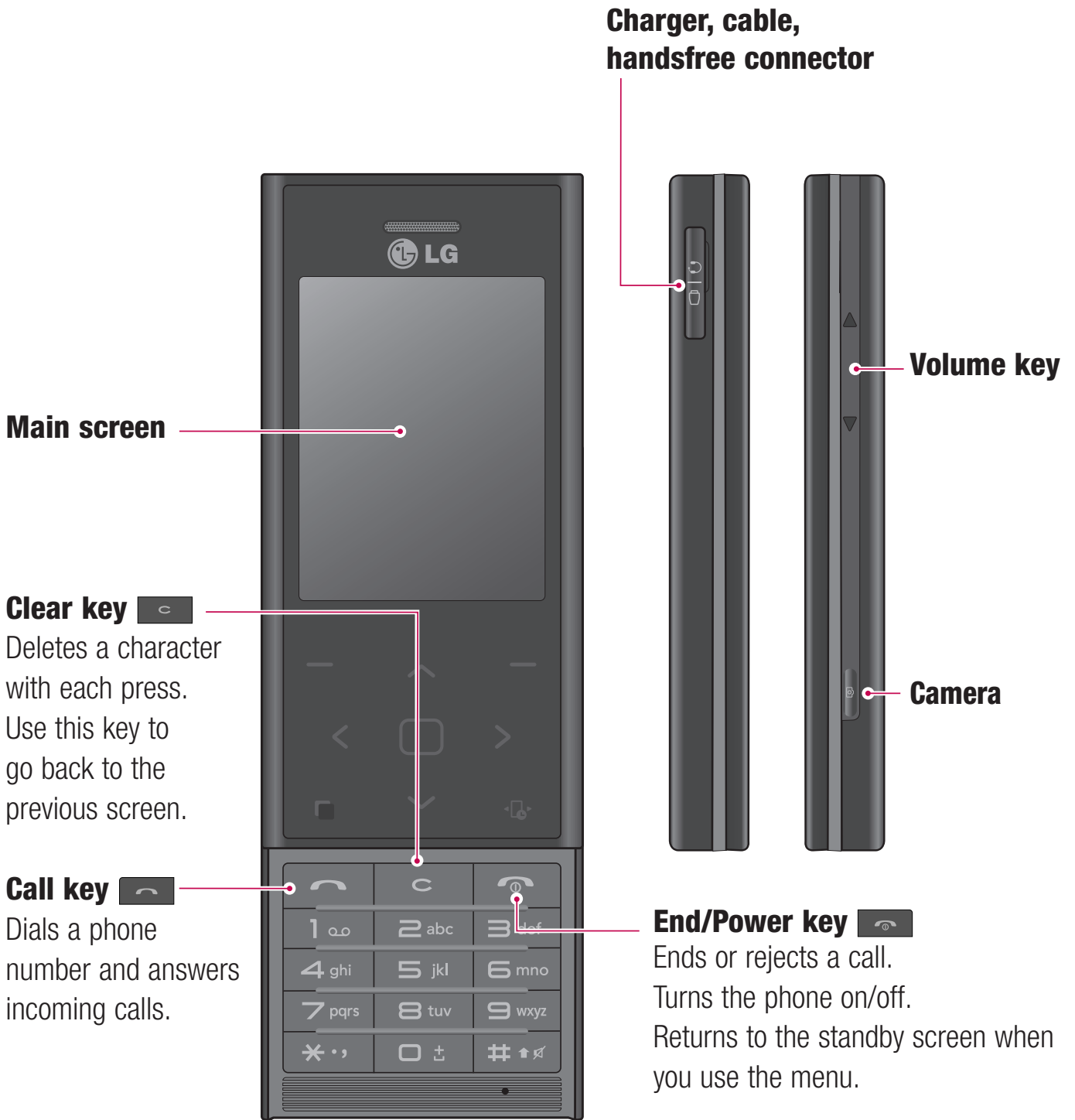

Open view

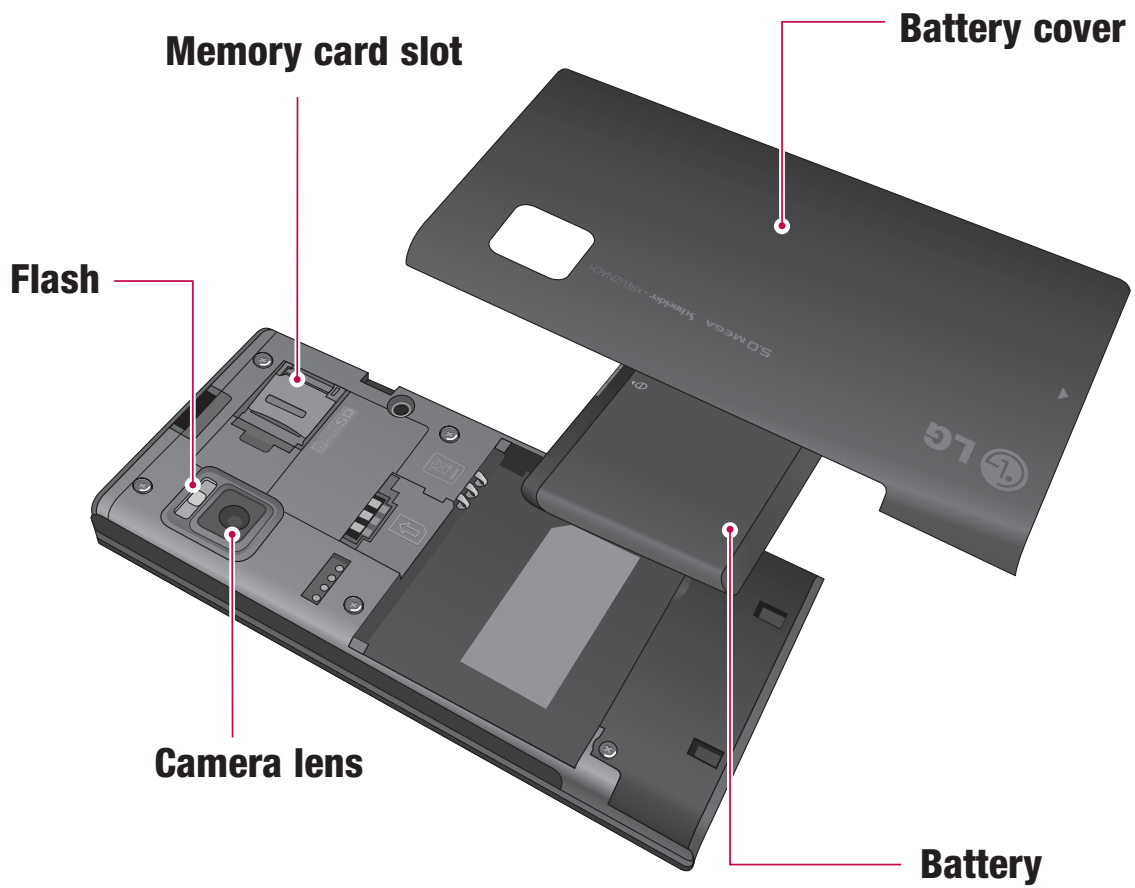

Installing the SIM and battery

1 Remove the battery cover and the battery

Slide down the battery cover and pull out the battery.

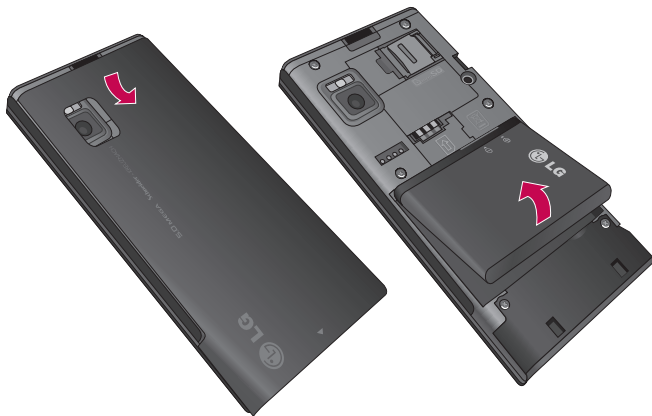

⚠ WARNING: Do not remove the battery when the phone is switched on, as this may damage the phone.

2 Install the USIM card

Slide the USIM card into the USIM card holder. Make sure the gold contact area on the card is facing downwards. To remove the USIM card, gently pull it outwards.

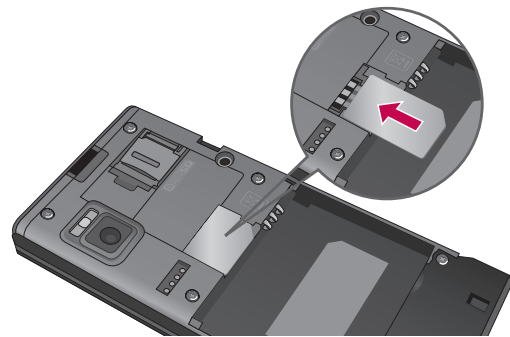

3 Install the battery

Insert the top of the battery into the top edge of the battery compartment first. Ensure that the battery contacts align with the phone's terminals. Press the bottom of the battery down until it clips into place.

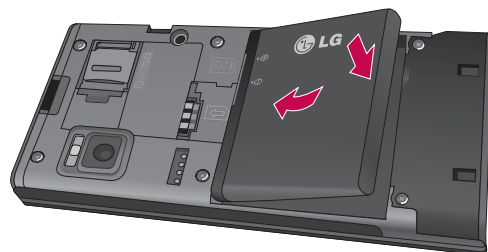

Memory card

Installing a memory card

You can expand the memory space available on your phone using a memory card. The BL20 will support a memory card of up to 16 GB.

TIP! A memory card is an optional accessory.

Open the slide covering the memory card slot. Slide the memory card into the slot, until it clicks into place. Make sure that the gold contact area is facing downwards.

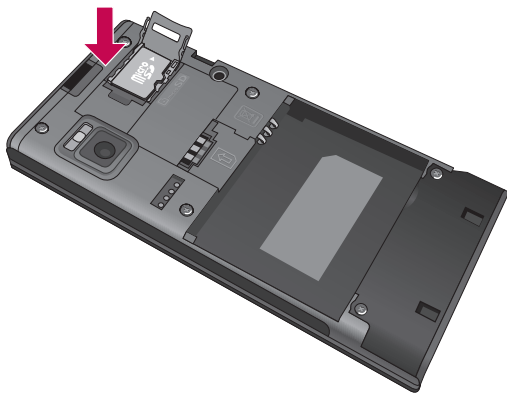

Removing the memory card

Open the slide and carefully remove the memory card by gently pushing it as shown in the following diagram:

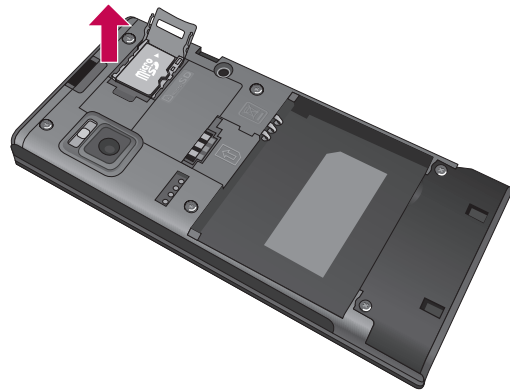

Formatting the memory card

If your memory card is not already formatted, you will need to do so before you can begin using it.





- 1 From the standby screen press **Menu** and select **Settings**.
- 2 Choose **Memory status** and select **External memory**.
- 3 Press **Format** and enter the password, which is set to 0000 as default. Your card will be formatted and ready to use.
- 4 To view the new formatted folders on your BL20 press **Menu** and select **My stuff**. Choose **External memory**.

WARNING: When you format your memory card, all the content will be wiped. If you do not want to lose the data on your memory card, back it up first.

Your standby screen

The quick keys

The quick keys provide easy, one-press access to your most used functions.

-  Select to open your message editor.
-  Select to choose a sound profile for your phone.
-  Select to open the quick menu.
-  Select to open contacts.

The main menu

The main menu provides twelve menu options. To open the main menu:

- 1** Select **Menu**.
- 2** The main menu will appear on the screen.
- 3** Move the highlighted image onto your desired position. And select center key to open.

Advice to the customer

In order to allow better antenna sensitivity LG suggest that you hold the handset as shown in the figure below.













Please do not cover the antenna area with your hand during a call or when using a Bluetooth connection. It may interfere and degrade signal quality.









Your standby screen

The status bar

The status bar uses various icons to indicate things like signal strength, new messages and battery life, as well as telling you whether your Bluetooth is active.



Below is a table explaining the meaning of icons you're likely to see in the status bar.

Icon	Description
	Network signal strength (number of bars will vary)
	No network signal
	GPRS available
	EDGE available
	Flight mode is activated
	Calls are diverted
	Roaming service
	Bluetooth® is activated
	WAP service is connected
	An alarm is set
	Schedule

Icon	Description
	New message
	New voice message
	General profile in use
	Silent profile in use
	Vibrate profile in use
	Outdoor profile in use
	Headset profile in use
	Remaining battery life
	Battery empty

Calls

Making a call

- 1 Key in the number using the keypad. To delete a digit press .
- 2 Press  to initiate the call.
- 3 To end the call, press .

TIP! To enter + when making an international call, press and hold **0**.

Making a call from your contacts

- 1 Select **Contacts** from the Standby screen.
- 2 Using the keypad, enter the first letter of the contact you want to call. For example, for Office, press **6** three times.
- 3 Select **Call** or press  to initiate the call.

Answering and rejecting a call

When your phone rings, press **Accept** or press  to answer the call.

While your phone is ringing, press the lock key, then select **Silent** to mute the ringing. This is great if you have forgotten to change your profile to **Silent** for a meeting.

Press  or select **Reject** to reject the incoming call.

Adjusting the call volume

To adjust the volume during a call, press the lock key, then press the volume key on the right hand side of your phone.

Calls

Speed dialling

You can assign a speed dial number to a contact you call frequently.

- 1 Press **Contacts** and press menu, then select **Speed dials**.
- 2 Your voicemail is set to speed dial 1 and you cannot change this. Select any other number either by using the navigation key arrows and selecting **Assign** or by pressing the hard key number.
- 3 Your address book will open. Select the contact you'd like to assign to that number using the navigation arrows, then select **OK**.

To call a speed dial number, press and hold the assigned number until the contact appears on screen. The call will initiate automatically; there's no need to press .

Using call divert

- 1 Select **Menu**, select **Settings** and choose **Call**.
- 2 Select **Call divert**.
- 3 Choose whether to divert all calls, when there is not answered, when you are out of reach.
- 4 Choose **Activate** and select whether to divert to another number or your favourite number.
- 5 Enter your divert number or select **Search** to browse **Contacts** for your divert number.

Note: Charges are incurred for diverting calls. Please contact your network provider for details.

TIP! To turn off all call diverts, choose **Deactivate all** from the **Call divert** menu.

Using call barring

- 1 Select **Menu**, select **Settings** and choose **Call**.
- 2 Select **Call barring** and choose **Voice calls**.
- 3 Choose options:
- 4 Select **Activate** and enter the call barring password. Please check with your network operator for this service.

TIP! Select **Fixed dial number** from the **Call** menu to turn on and compile a list of numbers which can be called from your phone. You'll need your PIN2 code from your operator. When activated, only numbers included in the fixed dial list can be called from your phone.

Contacts

Searching for a contact

- 1 Select **Contacts** from the standby screen, and choose **Search**.
- 2 Using the keypad enter the first letter of the contact you want to call. For example, for Office, press **6** three times.
- 3 To scroll through the contacts and their different numbers use the navigation arrows.

Adding a new contact

- 1 Select **Contacts** and choose **Create new contact**.
- 2 Choose whether to store your new contact on your **Phone** or **SIM** card.
- 3 Enter all the information you have in the fields provided and select **Save**.

Or, using the slightly quicker method...

- 1 Enter the number you wish to store on the standby screen and select **Options**.
- 2 Choose **Save** or **Add to existing contact**.
- 3 Enter the relevant information as above and select **Save**.

Note: When you are storing a contact's email address, press ***..** to enter a symbol and scroll with the navigation arrows until you see **@**.

Contact options

There are many things you can do when viewing a contact. Here's how to access and use the Options menu:

- 1 Open the contact you'd like to use. See **Searching contacts** above.
- 2 Select **Options** to open the list of options. From here you can:
 - Edit** - Change any of the contact's details.
 - New message** - Send a message to the contact. If the contact has an email address, select whether you'd like to send a **Message** or **Email**.
 - Send via** - Send the contact's details to another person as a business card. Choose to send as a **Text message**, **Multimedia message**, via **Bluetooth** or by **Email**.
 - Delete** - Delete the contact. Select **Yes** if you are sure.
 - New contact** - Add a new contact.

Multi delete - Mark multiple contacts to delete.

Copy to SIM/phone - Choose to move or copy to the SIM card or phone (depending on where you originally saved the contact).

Adding a contact to a group

You can save your contacts into groups, for example, keeping your work colleagues and family separate.

- 1 Select **Contacts** and choose **Groups**.
- 2 Scroll to the group you wish to add a contact to and select **View** then select **Add**.
- 3 Your contacts will open. Scroll to any contacts you would like to add to the group and press , then select **Done**.
- 4 Select **Yes** if you are sure.

TIP! You can assign a ringtone or icon to a group. Select the group you wish to assign the ringtone or icon to and select **Options** and choose an item you want.

Renaming a group

You can rename any of the groups to fit your lifestyle.

- 1 Select **Contacts** and choose **Groups**.
- 2 Select a group you want to rename.
- 3 Choose **Options**, select **Rename** and enter your new group name.
- 4 Select **Save**.

Note: You can only assign a contact to a group or add a picture to a contact that is saved in your phone (not SIM) memory.

Messaging

Messaging

Your BL20 includes functions related to SMS (Short Message Service), MMS (Multimedia Message Service) and email, as well as the network's service messages. Simply press **Menu** and select **Messaging**.

Sending a message

- 1 Press **Menu**, select **Messaging** and choose **Create new message**.
- 2 Choose **Message** to send an SMS or MMS.
- 3 A new message editor will open. Message editor combines SMS and MMS into one intuitive and easy to switch between mode. The default setting of the message editor is SMS mode.
- 4 Enter your message using either the T9 predictive mode or Abc manual mode. See **Entering text** to see how to switch between the different text entry modes.
- 5 Select **Options** and choose **Insert** to add an **Image, Sound, Video, Symbol, Text template, Emoticon, Name & Number, New slide, Subject** or **More (Contact/My business card/Schedule)**.
- 6 Press the centre key **Send to**.
- 7 Enter the phone number or press **Options** and select **Contacts** or **Recent list** to open your contacts list. You can add multiple contacts.
- 8 Select **Send**.





WARNING: If an **Image, Sound, Video, New slide** or **Subject** is added to the message editor, it will be automatically converted to MMS mode and you will be charged accordingly.

Entering text

You can enter alphanumeric characters using the phone's keypad. For example, storing names in Contacts, writing a message and creating scheduling events in the calendar all require entering text. The following text input methods are available in the phone: T9 predictive mode, ABC manual mode and 123 mode.

Note: Some fields may allow only one text input mode (e.g. telephone number in address book fields).

To turn on T9 mode in the text entry field, choose **Options**, select **Set T9** and choose **On** or simply press  and hold for several seconds. With T9 on, you can switch text input mode by pressing . You will notice the text input mode indicator in the upper left corner of the display.

To input a symbol in the text entry field, press the  key and select a symbol, then select **OK**.

Complete each word with a space by pressing **0**.

To delete a character, press  key.

T9 predictive mode

T9 predictive mode uses a built-in dictionary to recognise words you're writing based on the key sequences you press. Simply press the number key associated with the letter you want to enter, and the dictionary will recognise the word once all the letters are entered. For example, press **8, 3, 5, 3, 7, 4, 6, 6, 3** to write 'telephone'.

If the word you want doesn't appear, select **Options** and select **New T9 word**, then you can enter the word using ABC manual mode. Your word will be added to the dictionary.

Note: You can select a different T9 language by pressing **Options** and select **Writing language**.

ABC manual mode

In ABC manual mode you may need to press the key repeatedly to enter a letter. For example, to write 'hello', press **4** twice, **3** twice, **5** three times, **5** three times again, then **6** three times.

123 mode

Type numbers using one keystroke per number. You can also add numbers whilst in letter modes by pressing and holding the desired key.

Messaging

Message folders

Press **Menu**, select **Messaging**. The folder structure used on your BL20 is fairly self-explanatory.

Inbox - All the messages you receive are placed into your Inbox. From here you can reply, forward and more, see below for details.

Drafts - If you don't have time to finish writing a message, you can save what you have done so far here.

Outbox - This is a temporary storage folder while messages are being sent.

Sent - All the messages you send are placed into your Sent folder.

Templates - A list of useful messages, already written for a quick reply.

Managing your messages

You can use your **Inbox** to manage your messages.

1 Press **Menu**, select **Messaging** and choose **Inbox**. Or, a quicker way is to select  on the stand by screen to edit a new message.

2 Select **Options** and then choose to:

Delete - Delete the selected message.

Reply - Send a reply to the selected message.

Forward - Send the selected message on to another person.

Make call - Call the person who sent you the message.

Information - View the details of a message, for example, the time it was sent.

Copy/Move - Choose to copy or move the selected message to the SIM card or phone.

Multi selection - You can mark multiple messages and then delete or move to myfolder for marked messages.

Filter - You can filter certain type of messages (for example text message).

If you see the message No space for SIM message, you should delete some text messages with  from your message box.

If you see the message No space for messages, you should delete messages to create space.

Using templates

You can create templates for the **Text** and **Multimedia** messages you send most frequently. There are some templates already on your phone, which can be edited if you wish.

- 1 Press **Menu**, select **Messaging** and choose **Templates**.
- 2 Choose **Text** or **Multimedia**. You can then select **Options** and choose **Edit** to change existing templates, to add **New template** or to **Delete** templates.
- 3 To send a Multimedia template, select the one you want to send, choose **Options** and select Write multimedia message.
- 4 Select a contact and select **Send**.

Camera

Taking a quick photo

- 1 Hold the camera key down on the right side of the handset. The camera's viewfinder will appear on screen.
- 2 Holding the phone horizontally, point the lens towards the subject of the photo.
- 3 Press the camera key halfway. A focus box will appear in the centre of the viewfinder screen. Position the phone so you can see the subject of your photo in the focus box. When the focus box turns green, the camera has focused on your subject.
- 4 Press the centre soft key or press the camera key all the way down to take a photo.

Note: You can also access the camera menu from the standby screen. Select **Menu** and select **Camera**, scroll down to and select **Camera** to open the viewfinder.

After you've taken your photo

Your captured photo will appear on the screen. The name of the image runs along the bottom of the screen and you will see five options displayed on the right side of the screen.

 **Images** - Select to look at the other photos in your album. Your current photo will be saved.

 **Send** - Select to send the photo as a **Multimedia message** or **Email**.

 **New image** - Take another photo straightaway. Your current photo will be saved.

 **Use as** - Select to open a sub menu to set your image as **Wallpaper** or **Picture ID**.

 **Delete** - Delete the photo you have just taken and confirm by selecting **Yes**. The viewfinder will reappear.

Getting to know the viewfinder

Note: You can adjust the zoom using the volume key on the left side of the phone. The zoom function is only available when the resolution is set to 2048x1536 or below. See

Changing the image size.

TIP! When using the camera, power consumption increases. If  icon appears indicating low battery, recharge the battery before use.

Viewing your saved photos

- 1 You can access your saved photos from within the camera mode and captured screen. From the viewfinder, simply select  on the navigation key. From the standby screen you should select **Menu**, then select **My stuff** and **Images**.
- 2 Your gallery will appear on screen.
- 3 Use the navigation keys to select the photo you want to view and select **View** to enlarge it.

Setting a photo as Wallpaper or Picture ID

From your image gallery, use the navigation keys to select an image and choose **Options** and **Set as** to use the selected image as **Wallpaper** or **Picture ID** for one of your contacts.

Note: Picture ID can only be added to contacts saved to your phone, not your SIM.

Video camera

Shooting a quick video

- 1 The video camera's viewfinder will appear on screen.
- 2 Point the camera lens towards the subject of the video.
- 3 Press the camera key on the right side of the handset to start recording.
- 4 **REC** will appear in the bottom right center and a timer will show the length of your video.
- 5 To pause the video select **Pause** and resume by selecting **Resume**.
- 6 Select **Stop** to stop recording.

Note: You can also access the **Video camera** from the standby screen. Select **Menu** and select **Camera**, scroll down and select **Video camera** to open the viewfinder.

After you've shot your video

The name of the video runs along the bottom of the screen and five options will be displayed on the right side of the screen.

Delete - Delete the video you have just recorded and confirm by selecting Yes. The viewfinder will reappear.

New - Select to shoot another video straight away. Your current video will be saved.

Play - Select to play the video you have just recorded.

Send - Select to send the video as a **Multimedia message** or **Email**.

Videos - Select to look at the other video clips in your album. Your current video clip will be saved.

Watching your saved videos

- 1** You can access your saved videos either from within video camera mode or from the standby screen. From the standby screen you should select **Menu**, then select **My stuff** and **Videos**.
- 2** Your gallery will appear on screen.
- 3** Use the navigation keys to select the video you want to view and press the centre soft key to watch it.

Adjusting the volume when viewing a video

To adjust the volume of the audio on a video whilst it is playing, use the volume keys on the right side of the handset.

MP3 player

MP3 player

Your LG BL20 has a built-in MP3 player so you can play all your favourite music.

To access the MP3 player, or select **Menu** and select **Music** then **MP3 player**. From here you have access to:

All songs - Contains all of the songs you have on your phone.

My playlist - Contains any playlists you have created as well as **On the go**, **Recent songs** and **Favourite songs**.

Artists - Browse through your music collection by artist.

Albums - Browse through your music collection by album.

Genres - Browse through your music collection by genre.







Transferring music onto your phone

The easiest way to transfer music onto your phone is via Bluetooth or your sync cable. To transfer using Bluetooth:

- 1 Make sure both devices have Bluetooth switched on and are visible to one another.

- 2 Select the music file on the other device and choose to send it via Bluetooth.
- 3 When the file is sent you will have to accept it on your phone by selecting **Yes**.
- 4 The file should appear in **All songs**.

Playing a song

- 1 Press **Menu** and select **Music**, then choose **MP3 player**, or press  from the standby screen.
- 2 Choose **All songs** then select the song you want to play. Select .
- 3 Select  to pause the song.
- 4 Select  to skip to the next song.
- 5 Select  to skip to the previous song.
- 6 Select  to stop the music and return to the MP3 player menu.

TIP! To change the volume while listening to music, use the volume keys on the side of your phone.

Using options while playing music

Select **Options** and choose from:

Minimise - Hide the music player screen so that you can continue using your phone as normal while music is playing.

View playlist - Look at the playlist you are currently listening to.

Add to playlist - Adds the current track to a playlist.

Set as - Set the current track as your **Ringtone** or **Message tone**.

Information - You can view information about the MP3 file you are listening to.

Settings - Change the Shuffle, Repeat, or Equalizer settings.

Creating a playlist

You can create your own playlists by choosing a selection of songs from the **All songs** folder.

- 1 Press **Menu** and select **Music**.
- 2 Choose **MP3 player**, then select **My playlist**.
- 3 Press **Options** and select **New playlist**, enter the playlist name and press **Save**.

- 4 The **New playlist** folder will show. Select all of the songs that you would like to include in your playlist by scrolling to them and selecting .

- 5 Select **Save** to store the playlist.

Playing a playlist

- 1 Press **Menu** and select **Music**.
- 2 Choose **MP3 player**, then select **My playlist**.
- 3 Select the playlist you would like to play and select **View**, then select .

Editing a playlist

From time to time, you may want to add new songs or delete songs from a playlist.

If you want to organise your playlists, you can edit them using the **Options** menu.

- 1 Press **Menu** and select **Music**.
- 2 Choose **MP3 player**, then select **My playlist**.
- 3 Scroll to the playlist you want to edit and select **View**, then select **Options**. Choose from:

Add - You can add songs to the playlist using this option.

MP3 player

Remove - Remove a song from the playlist. Select **Yes** to confirm.

Multi remove - Delete selected songs from the playlist.

Remove all - Remove all of the songs from the playlist.

Information - View the playlist information.

Deleting a playlist

- 1 Press **Menu** and select **Music**.
- 2 Choose **MP3 player**, then select **My playlist**.
- 3 Scroll to the playlist you want to delete and select **Options**.
- 4 Select **Delete all** and select **Yes** to confirm.

Note:

As a result of the Digital Rights Management (DRM) system, some of the media items you download from the Internet or receive by MMS may have a "Purchase right" menu to access them. You can acquire the key to purchase the right from the website which owns the rights to the contents.

Music is copyright protected in international treaties and national copyright laws. It may be necessary to obtain permission or a licence to reproduce or copy music. In some countries national law prohibits private copying of copyrighted material. Please check the national legislation of the applicable country concerning the use of such material.

My stuff

You can store any multimedia files into your phone's memory so that you have easy access to all of your pictures, sounds, videos and games. You can also save your files to a memory card. The advantage of using a memory card is that you can free up space on your phone's memory.

All your multimedia files will be saved in **My stuff**. Select **Menu** then select **My stuff** to open a list of folders.

Images

Images contains a folder of default images and default flash files pre-loaded onto your phone, images downloaded by you and images taken on your phone's camera.

Images options menu

The options which are available to you in **Images** depend on what type of image you have selected. All of the options will be available for pictures you have taken on the phone's camera. Only the **View**, **Set as**, **File info**, **Slide show**, **Sort by** and **List view / Thumbnail view** options are available for default images.

In the **Images** folder, select **Options** to bring up your list of options.

Delete - Delete the selected image.

Set as - Set the selected image as your **Wallpaper** or as a **Picture ID**.

Send via - Send the selected image to a friend via **Multimedia message**, **Bluetooth** or **Email**.

Note: The image may need to be resized before it can be sent by MMS.

Print via - Print an image file via **Bluetooth**.

Slide show - See **Creating a slide show** on page 45.

New folder - Create a new folder within the main Images folder.

Multi-selection - Select more than one.

Delete all - Delete all the photos in your Images folder.

Sort by - Arrange your images by **Date**, **Type** or **Name**.

List view / Thumbnail view - Change the way you view your photos.

My stuff

Sending a photo

- 1 Press **Menu** then select **My stuff**.
- 2 Select **Images**.
- 3 Select a photo and choose **Options**.
- 4 Select **Send via** and choose from **Multimedia message**, **Bluetooth** or **Email**.
- 5 If you choose **Multimedia message** or **Email**, your photo will be attached to the message and you can write and send the message as normal. If you choose **Bluetooth**, you will be prompted to turn Bluetooth on and your phone will search for a device to send the picture to.

Organising your images

- 1 Press **Menu** then select **My stuff**.
- 2 Select **Images**.
- 3 Choose **Options** then select **Sort by**.
- 4 Choose from **Date**, **Type** or **Name**.

Deleting an image

- 1 Press **Menu** then select **My stuff**.
- 2 Select **Images**.
- 3 Select an image and press **Options**.
- 4 Select **Delete**.

Deleting multiple images

- 1 Press **Menu** then select **My stuff**.
- 2 Select **Images**.
- 3 Choose **Options** and select **Multi-selection**.
- 4 A box will appear next to each image. Select each image and select to mark it. To unmark an image, select again so that the tick disappears from the box. Or, you can select **Options** then choose **Mark all** or **Unmark all**.
- 5 Once you have marked all of the appropriate boxes, select **Delete** and confirm you want to delete all of the marked images.

Creating a slide show

If you want to look at all of the images on your phone or scan through what you've got, you can create a slide show to save you from having to open and close each individual image.

- 1 Press **Menu** then select **My stuff**.
- 2 Select **Images**.
- 3 Select the photo you would like to begin the slide show and select **Options**.
- 4 Choose **Slide show** and it will begin.
- 5 Press **Pause** to pause the slide show and **Quit** to end the slide show and return to the **Images** folder.

Selecting **Options** during the slide show presents further options:

View - Choose between **Full image** and **Full screen**. Select **Landscape** to change the orientation of the image.

Repeat on / off - Decide whether you want the slide show on repeat or not.

Sounds

The **Sounds** folder contains the **Default sounds**, your voice recordings and sound files downloaded by you. From here you can manage, send or set sounds as ringtones.

Using a sound

- 1 Press **Menu** then select **My stuff**.
- 2 Scroll to and select **Sounds**.
- 3 Select **Default sounds** or choose from the list of voice recording files.
- 4 Select a sound and press ► to listen to it.
- 5 Select **Options**, select **Set as** and choose from **Ringtone**, **Ringtone ID** and **Message tone**.

Videos

The **Videos** folder shows the list of downloaded videos and videos you have recorded on your phone.

Watching a video

- 1 Press **Menu** then select **My stuff**.
- 2 Scroll to and select **Videos**.
- 3 Select a video and press ►.

My stuff

Using options while video is paused

By selecting **Options**, the video you are playing will be in pause mode and you can choose from:

Delete - Delete the video.

Send via - Send the video to a friend via **Multimedia message**, **Bluetooth** or **Email**.

Information - View the Name, Size, Date, Time, Type and Copyright details of the selected file.

Sending a video clip

- 1 Press **Menu** then select **My stuff**.
- 2 Scroll to and select **Videos**.
- 3 Select the video clip you want and press **Options**.
- 4 Press **Send via** and choose from **Multimedia message**, **Bluetooth** or **Email**.
- 5 If you choose **Message** or **Email**, your video clip will be attached to the message and you can write and send the message as normal. If you choose **Bluetooth**, you will be prompted to turn Bluetooth on and your phone will search for a device to send the video to.

Note: The video may need to be resized before it can be sent by MMS. Some videos may be too large to send by MMS at all.

Video options menu

In the **Videos** folder, press **Options** to bring up the following list of options.

Delete - Delete the selected video.

Send via - Send the selected video to a friend via **Multimedia message**, **Email** or **Bluetooth**.

New folder - Create a new folder within the main Videos folder.

Multi-selection - Select more than one.

Delete all - Delete all the clips in your Videos folder.

Sort by - Arrange your videos by **Date**, **Type** or **Name**.

Auto next play - Allows to set the play mode: **Off**, **Repeat once** and **Repeat all**.

- **Off:** Plays the selected file.
- **Repeat once:** Plays all files in a list once.
- **Repeat all:** Continues to play all files in a list repeatedly.

List view / Thumbnail view - Change the way you view your videos.

External memory

If you've inserted a memory card it will be displayed as a folder within **My stuff**. Your external memory folder will be divided into four further folders: **Images**, **Sounds**, **Videos** and **Others**. Each folder will contain all the files of that type which are saved to your memory card rather than your handset.

Using your phone as a mass storage device

Your BL20 can be used as a mass storage device, just like a USB stick. This is a great way of moving your files from your computer to your phone. If you've inserted a memory card, when connecting as **Mass storage**, the phone will be displayed as two drives on your computer: the handset memory and external memory.

- 1 Press **Menu**, select **Settings** and **Connectivity**.
- 2 Select **USB Connection**.
- 3 Scroll to **Mass storage** and select **OK**.
- 4 Insert the smaller end of the USB cable into the USB cable connector on the edge of the BL20. Plug the larger end into the USB port of your computer.
- 5 A removable disk folder will open automatically on your computer, two if you have a memory card inserted, showing all the folders on your phone or memory card.
- 6 Drag and drop your images, videos, music or documents into the correct folders.
- 7 Safely remove your phone by clicking on the **Safely remove hardware** icon in your desktop toolbar.
- 8 When you want to then access a file, for example an image, press **Menu**, then select **My stuff** followed by **External memory** then **Images**. All the images you transfer will be contained in this file.

My stuff

Transferring a file to your phone

You can also transfer files from your computer to your phone using Bluetooth.

- 1 Make sure your phone and computer have Bluetooth switched on and are visible to one another.
- 2 Use your computer to send the file via Bluetooth.
- 3 When the file is sent you will have to accept it on your phone by selecting **Yes**.
- 4 The file will be saved within the appropriate folder depending on its type. So for example, photographs will be saved in the **Images** folder and music in the **Sounds** folder. If your phone cannot identify the file type, the file will be saved in the **Others** folder.

Note: Files sent using Bluetooth will be saved to the phone memory.

Sending and receiving your files using Bluetooth

Bluetooth is a great way to send and receive files as no wires are needed and connection is quick and easy. You can also connect to a Bluetooth headset to make and receive calls.

Before you can start sharing files using Bluetooth, you will need to pair your phone with another Bluetooth device. For information on pairing devices, see **Pairing with another Bluetooth device**.

To switch Bluetooth on:

- 1 Press **Menu** and select **Settings** and **Connectivity**, then choose **Bluetooth**.
- 2 Select **Bluetooth on/off** and choose **On**.
- 3 Select **Off** to switch Bluetooth off.

To send a file:

- 1 Open the file you want to send, typically this will be a photo, video or music file.
- 2 Select **Options** and choose **Send via**, then **Bluetooth**.
- 3 Select **Yes** to turn Bluetooth on if it is not already activated.

- 4 Your BL20 will automatically search for other Bluetooth enabled devices within range.
- 5 Choose the device you want to send the file to and select **Send**.

To receive a file:

- 1 To receive files, your Bluetooth must be both **On** and **Visible**. See **Changing your Bluetooth settings** on page 59 for more information.
- 2 A message will prompt you to accept the file from the sender. select **Yes** to receive the file.

TIP! Keep an eye on the progress bar to make sure your file is sent.

Note The Bluetooth® word mark and logos are owned by the Bluetooth SIG, Inc. and any use of such marks by LG Electronics is under licence. Other trademarks and trade names are those of their respective owners.

Games and Apps

Games and Apps

Your BL20 comes with preloaded games to keep you amused when you have time to spare. If you choose to download any additional games or applications they will be saved into this folder.

Playing a game

- 1 Press **Menu** and select **Games & Apps**.
- 2 Select **Games**.
- 3 Choose the game you want to play and select **Play**.

Browser

With a browser at the tip of your fingers, you can get up to date news and weather forecasts as well as information on sports or traffic whenever you need it. In addition, the browser allows you to download the latest music, ringtones, wallpapers and games.

Accessing the web

- 1 Press **Menu** and select **Browser**.
- 2 To access the browser homepage directly, select **Home**. Alternately, select **Enter address** and type in your desired URL, followed by **Connect**.

Note: An additional cost is incurred when connecting to this service and downloading content. Check your data charges with your network provider.

Adding and accessing your bookmarks

For easy and fast access to your favourite websites, you can add bookmarks and save web pages.

- 1 Press **Menu** and select **Browser**.
- 2 Select **Bookmarks**. A list of your bookmarks will appear on the screen.
- 3 To add a new bookmark, select **Options** and choose **New bookmark**. Enter a name for your bookmark followed by the URL.
- 4 Press **Save**. Your bookmark will now appear in the list of bookmarks.
- 5 To access the bookmark simply scroll to the required bookmark and select **Connect**. You will be connected to your bookmarked page.

Browser

Saving a page

- 1 Access your required web page as described.
- 2 Choose **Options** and select **Save** items, Save this page.
- 3 Select **OK**.

Accessing a saved page

- 1 Press **Menu** and select **Browser**.
- 2 Select **Saved pages**.
- 3 Select the required page and press **Open**.

TIP! This menu will also allow you to delete saved pages.

Viewing your browser history

- 1 Press **Menu** and select **Browser**.
- 2 Select **History** and select **OK**.
- 3 A list of web pages you have accessed recently will be displayed. To access one of these pages, select **Open**.

Changing the web browser settings

- 1 Press **Menu** and select **Browser**.
- 2 Select **Browser settings**.
- 3 You can choose the way your mobile handles, displays and uses information when browsing the internet. You can amend settings within **Browser profiles**, **Rendering mode**, **Cache**, **Cookies**, **Security certificates**, **Show image**, **JavaScript**.
- 4 Once you have changed your settings, select **OK**.

Settings

Changing your display settings

- 1 Press **Menu** and select **Settings**.
- 2 Select **Screen** and choose from:

Homescreen - Choose a wallpaper to appear on your screen display.

Backlight - Choose how long the backlight remains on for.

TIP! The longer the backlight is on for, the more battery power is used and you may need to charge your phone more often.

Brightness - Use the navigation keys to adjust the brightness. Choose from 40%, 60%, 80% or 100%, then select OK to save your change.

Font - Change the font size of the following : **Menu** and **List**.

Handset Theme - Quickly change the whole look of your screen.

Changing your security settings

Change your security settings to keep your BL20 and the important information it holds protected.

- 1 Press **Menu** and select **Settings**.
- 2 Select **Security** and choose from the list below:

PIN code request - Choose a PIN code to be requested when you turn your phone on.

Handset lock - Choose a security code to lock your phone **When power on**, **When SIM changed** or **Immediately**.

Change codes - Change your **Security code**, **PIN1 code** or **PIN2 code**.

Settings

Resetting your phone

Use **Reset** to reset all the settings to their factory definitions. You need the security code to activate this function.

Viewing memory status

Your BL20 has three memories available: the phone, the SIM card and an external memory card (you may need to purchase the memory card separately).

You can use the memory manager to determine how each memory is used and see how much space is available.

Press **Menu** and select **Settings**. Choose **Memory info**. and you will then see the current status of the memories (Common, Reserved, SIM card and External memory) in your BL20.

Changing your Bluetooth settings

- 1 Press **Menu** and select **Settings** and **Connectivity**, then choose **Bluetooth**.
- 2 Choose **settings**. Make your changes to:

My device visibility - Choose whether to **Show** or **Hide** your device to others.

My device name - Enter a name for your BL20.

My address - View your Bluetooth address.

Changing your connectivity settings

Your connectivity settings have already been set up by your network operator, so you can enjoy your new phone from the off. If you want to change any settings, use this menu.

Press **Menu** and select **Settings**. Choose **Connectivity**. Your options are:

Bluetooth - Set up your BL20 for Bluetooth use. You can adapt your visibility to other devices or search through devices your phone is paired with.

Network - Your BL20 connects automatically to your preferred network. To change these settings use this menu. You can also add new access points using this menu.

USB connection - Choose **Data service** and synchronise your BL20 using the LG PC Suite software to copy files from your phone. If you have a memory card inserted, select **Mass storage** to use your phone in the same way as you would use a USB stick. Connect to your computer and drag and drop files to the BL20 removable device folder.

Pairing with another Bluetooth device

By pairing your BL20 and another device, you can set up a passcode protected connection. This means your pairing is more secure.

- 1 Check your Bluetooth is **On** and **Visible**. You can change your visibility in the **Bluetooth settings** menu, by selecting **My device visibility**, then **visible**.
- 2 Select **Device list** from the Bluetooth menu and choose **New**.
- 3 Your BL20 will search for devices. When the search is completed **Pair** and **Refresh** will appear on screen.
- 4 Choose the device you want to pair with, select **Pair** and enter a passcode then choose **OK**.
- 5 Your phone will then connect to the other device, on which you should enter the same passcode.
- 6 Your passcode protected Bluetooth connection is now ready.

Using a Bluetooth headset

- 1 Check your Bluetooth is **On** and **Visible**.
- 2 Follow the instructions that came with your headset to place it in pairing mode and pair your devices.
- 3 Your BL20 will then automatically connect to your Bluetooth headset and switch to headset profile.

Accessories

These accessories were supplied with your BL20.

Charger

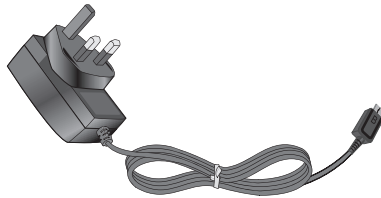

Data cable and CD

Connect and synchronise your BL20 and PC.

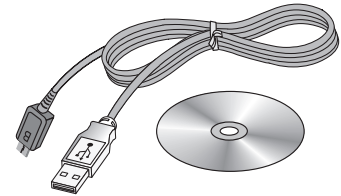

Battery



User Guide

Learn more about your BL20.

Stereo headset

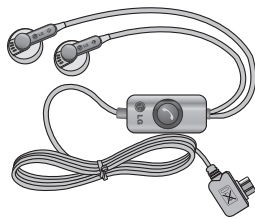

Note

- Always use genuine LG accessories. Failure to do this may invalidate your warranty.
- Accessories may be different in different regions; please check with our regional service company or agent for further inquiries.

Network service

The wireless phone described in this guide is approved for use on the GSM and W-CDMA networks.

A number of features included in this guide are called Network Services. These are special services that you arrange through your wireless service provider. Before you can take advantage of any of these Network Services, you must subscribe to them through your service provider and obtain instructions for their use from your service provider.

Technical data

General

Product name : BL20

System : GSM / W-CDMA

Ambient Temperatures

Max : +55°C (discharging)
+45°C (charging)

Min : -10°C

Declaration of Conformity



Suppliers Details

Name

LG Electronics Inc

Address

LG Electronics Inc. LG Twin Towers 20,
Yeouido-dong, Yeongdeungpo-gu, Seoul, Korea 150-721

Product Details

Product Name

GSM / W-CDMA Terminal Equipment

Model Name

BL20

Trade Name

LG

CE 0168

Applicable Standards Details

R&TTE Directive 1999/5/EC

EN 301 489-01 V1.6.1, EN 301 489-07 V1.3.1
EN 301 489-17 V1.2.1, EN 301 489-24 V1.3.1
EN 301 511 V9.0.2
EN 301 908-1 V3.2.1 EN 301 908-2 V3.2.1,
EN 300 328 V1.7.1
EN 50360:2001/EN62209-1:2006
EN 60950-1 : 2001

Supplementary Information

The conformity to above standards is verified by the following Notified Body(BABT)

BABT, Balfour House, Churchfield Road, Walton-on-Thames, Surrey, KT12 2TD, United Kingdom
Notified Body Identification Number : 0168

Declaration

I hereby declare under our sole responsibility that the product mentioned above to which this declaration relates complies with the above mentioned standards and Directives

European Standard Center
LG Electronics Logistics and Services B.V.
Veluwezoom 15, 1327 AE Almere, The Netherlands
Tel : +31 - 36- 547 - 8940, Fax : +31 - 36 - 547 - 8794
e-mail : jacob @ lge.com

Name

Issued Date

Seung Hyoun, Ji / Director

14.Aug. 2009

Signature of representative